



Patyegarang Project - Belrose

Transport Assessment

Prepared for: **Metropolitan Local Aboriginal Land Council**

18 September 2023

PROJECT INFORMATION

Project Name:	Patyegarang Project - Belrose
Client:	Metropolitan Local Aboriginal Land Council
Project Number:	2046
Prepared By:	JMT Consulting

DOCUMENT HISTORY

Document Title	Revision	Date issued	Author
Patyegarang Project Belrose TIA	Draft	14.05.21	JM
Patyegarang Project Belrose TIA	Draft 2	15.07.22	JM
Patyegarang Project Belrose TIA	Issue	14.09.22	JM
Patyegarang Project Belrose TIA	Rev A	03.02.23	JM
Patyegarang Project Belrose TIA	Rev B	06.07.23	JM
Patyegarang Project Belrose TIA	Rev C	18.09.23	JM

This document has been prepared on behalf of Metropolitan Local Aboriginal Land Council. Use of this document by a third party to inform decisions is the sole responsibility of that third party. J Milston Transport Consulting Pty Ltd assumes no liability with respect to any reliance placed upon this document. Reproduction of this document or any part thereof is not permitted without prior written permission of J Milston Transport Consulting Pty Ltd and Metropolitan Local Aboriginal

Table of Contents

1	Introduction	1
1.1	<i>Background</i>	1
1.2	<i>Background to Planning Proposal</i>	1
1.3	<i>Site location</i>	2
1.4	<i>Report purpose</i>	3
2	Existing Transport Conditions	4
2.1	<i>Travel patterns</i>	4
2.2	<i>Road network</i>	6
2.3	<i>Traffic volumes</i>	10
2.4	<i>Public transport</i>	11
2.5	<i>Walking and cycling</i>	12
3	Concept Plan	13
4	Transport Assessment	14
4.1	<i>Site access</i>	14
4.2	<i>Internal street network</i>	15
4.3	<i>Public transport assessment</i>	16
4.4	<i>Car parking</i>	17
4.5	<i>Active transport</i>	17
5	Traffic Analysis	19
5.1	<i>Traffic generation</i>	19
5.2	<i>Traffic distribution</i>	20
5.3	<i>Road infrastructure upgrades</i>	21
5.4	<i>Future traffic flows</i>	22
5.5	<i>Background traffic growth</i>	23
5.6	<i>Traffic modelling</i>	24
6	Traffic Analysis – Bushfire Evacuation	30
6.1	<i>Assumptions for bushfire evacuation</i>	30
6.2	<i>Traffic demands during bushfire evacuation</i>	32
6.3	<i>Road network performance during bushfire emergency</i>	33
6.4	<i>Sensitivity analysis</i>	34
7	Summary	35
	Appendix A: Traffic Modelling Outputs	36

Figures

Figure 1	Patyegarang Project site location.....	2
Figure 2	Existing travel patterns of residents adjacent to the site.....	4
Figure 3	Home location of workers travelling from Belrose.....	5
Figure 4	Road network serving the site.....	6
Figure 5	Road hierarchy	7
Figure 6	Forest Way near Morgan Road.....	8
Figure 7	Morgan Road.....	8
Figure 8	Oates Place / Forest Way intersection.....	9
Figure 9	Peak hour traffic flows – Forest Way / Morgan Road	10
Figure 10	Existing traffic volumes – Wakehurst Parkway / Oxford Falls Road	10
Figure 11	Bus network in the vicinity of the site	11
Figure 12	Existing pedestrian and cyclist facilities	12
Figure 13	Illustrative concept plan.....	13
Figure 14	Indicative vehicle site access arrangements.....	14
Figure 15	Indicative internal street network.....	15
Figure 16	Key walking routes to public transport stops.....	16
Figure 17	Indicative public walking trails and active transport routes	18
Figure 18	Traffic distribution assumptions.....	20
Figure 19	Existing bridge on Morgan Road at Oxford Falls	21
Figure 20	Concept plan for replacement of bridge at Oxford Falls	21
Figure 21	Forecast additional traffic flows.....	22
Figure 22	Historical traffic flows – Forest Way (Belrose)	23
Figure 23	Forest Way / Morgan Road – AM peak hour	24
Figure 24	Oxford Falls Road / Wakehurst Parkway – PM peak hour	25
Figure 25	Proposed upgrade to Morgan Road / Forest Way intersection.....	26
Figure 26	Forecast maximum queue length for right turning vehicles	28

Tables

Table 1	Forecast traffic generation	19
Table 2	Intersection level of service.....	25
Table 3	Traffic modelling results – Morgan Road / Forest Way.....	27
Table 4	Traffic modelling results – Wakehurst Parkway / Oxford Falls Road.....	29
Table 5	Forecast traffic demands (bushfire evacuation).....	32
Table 6	Traffic modelling results - bushfire evacuation scenario.....	33

1 Introduction

1.1 Background

JMT Consulting was engaged by the Metropolitan Aboriginal Land Council to prepare a transport assessment to support a Planning Proposal for the 'Patyegarang Project' site in Belrose, NSW.

1.2 Background to Planning Proposal

The purpose of this Planning Proposal is to implement the Development Delivery Plan for the subject site created under State Environmental Planning Policy (Planning Systems) 2021. The objective of the Planning Proposal is to create a residential community embodying strong conservation principles to support the enhancement of the unique environmental and Aboriginal cultural heritage characteristics of the site.

The intended outcome of the Planning Proposal is to amend the applicable local planning controls to accommodate a maximum of 450 residential dwellings with a variety of scale and character reflective of the dominant dwelling type in the Belrose locality, as well as a new cultural community centre and protection of aboriginal heritage sites.

An indicative draft structure plan has been developed by COX Architecture that is reflective of the site's opportunities and constraints in the areas of flora and fauna biodiversity, bushfire management, transport planning, Aboriginal heritage and stormwater management. The Planning Proposal intends to ensure development outcomes align with traditional indigenous 'Caring for Country' practices and relevant 'Connecting with Country' and 'Designing with Country' principles and strategies.

1.3 Site location

The site is located within the suburb of Belrose NSW, approximately 3 kilometres north of the Frenchs Forest Shopping Centre and approximately 21 kilometres north of the Sydney CBD. As indicated in Figure 1 below the site is bounded by Morgan Road which connects through to Forest Way.



Figure 1 Patyegarang Project site location

Source: COX Architecture

1.4 Report purpose

The purpose of the transport assessment is to understand the implications of the Planning Proposal on the adjacent transport network and identify any upgrades or mitigation measures required to support the future site development.

Specifically the assessment considers the following items:

- Existing transport conditions around the site, including:
 - Road network
 - Public transport
 - Walking and cycling network
 - Existing travel behaviours
- Forecast volume of traffic generated by the uses envisaged under the Planning Proposal in the critical peak hours, including the likely direction of travel.
- The overall net change in traffic flows at the Forest Way / Morgan Road intersection (key site access point) and the ability of the adjacent road network to accommodate the level of development proposed.
- Proposed vehicle access arrangements from the broader road network
- Proposed internal street network including proposed connections to the external road network.
- Ability of the road network to accommodate vehicle demands from the site during a major bushfire evacuation event.
- Staging and sequencing of any necessary infrastructure upgrades

2 Existing Transport Conditions

2.1 Travel patterns

Journey to work data from the 2016 census for people living in the immediate vicinity of the site is shown in Figure 2. The data indicates that the majority of residents currently rely on private vehicle as a mode of transport for work trips – with only 9% of resident trips made by public transport.

This low proportion of people using public transport is reflective of both the limited nature of public transport services and, in the case of people working in the Northern Beaches area, the relatively unconstrained and free parking environment.

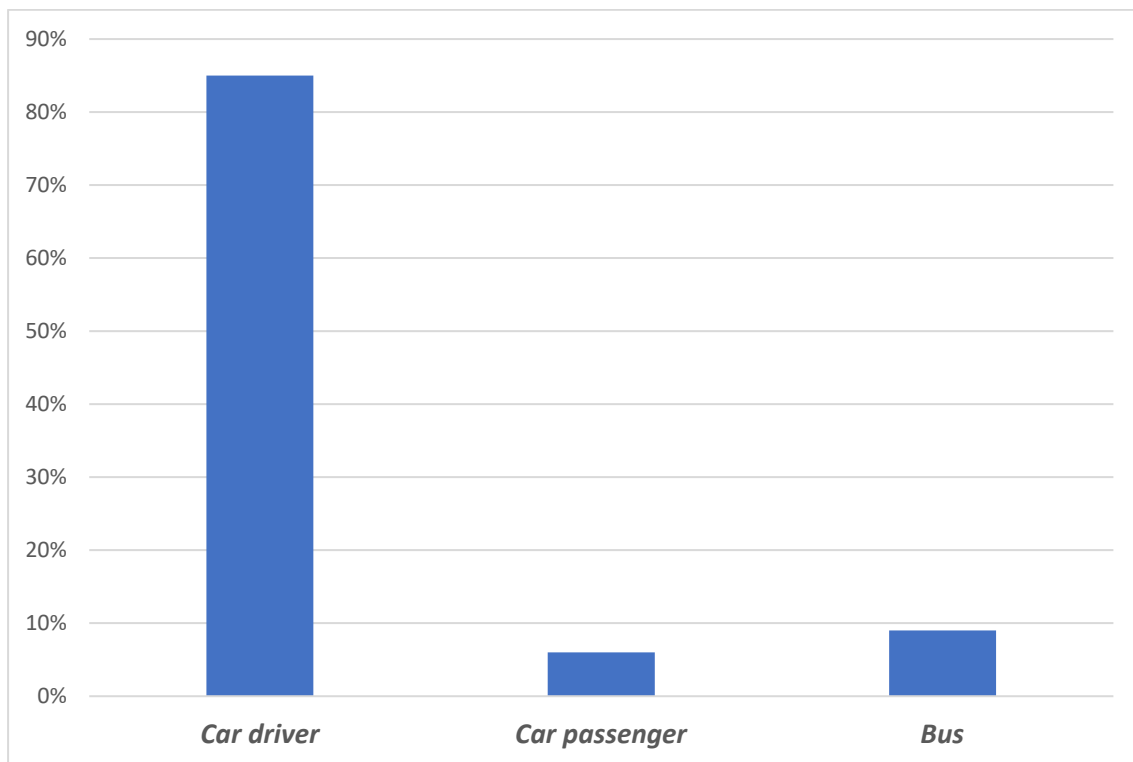

Figure 2 Existing travel patterns of residents adjacent to the site

Figure 3 shows that the majority of work related trips to the area surrounding the site originate from the Northern Beaches area, with only a small proportion originating from outside the LGA. This localised trip catchment indicates there is potential to increase public transport, walking and cycling usage from the site.

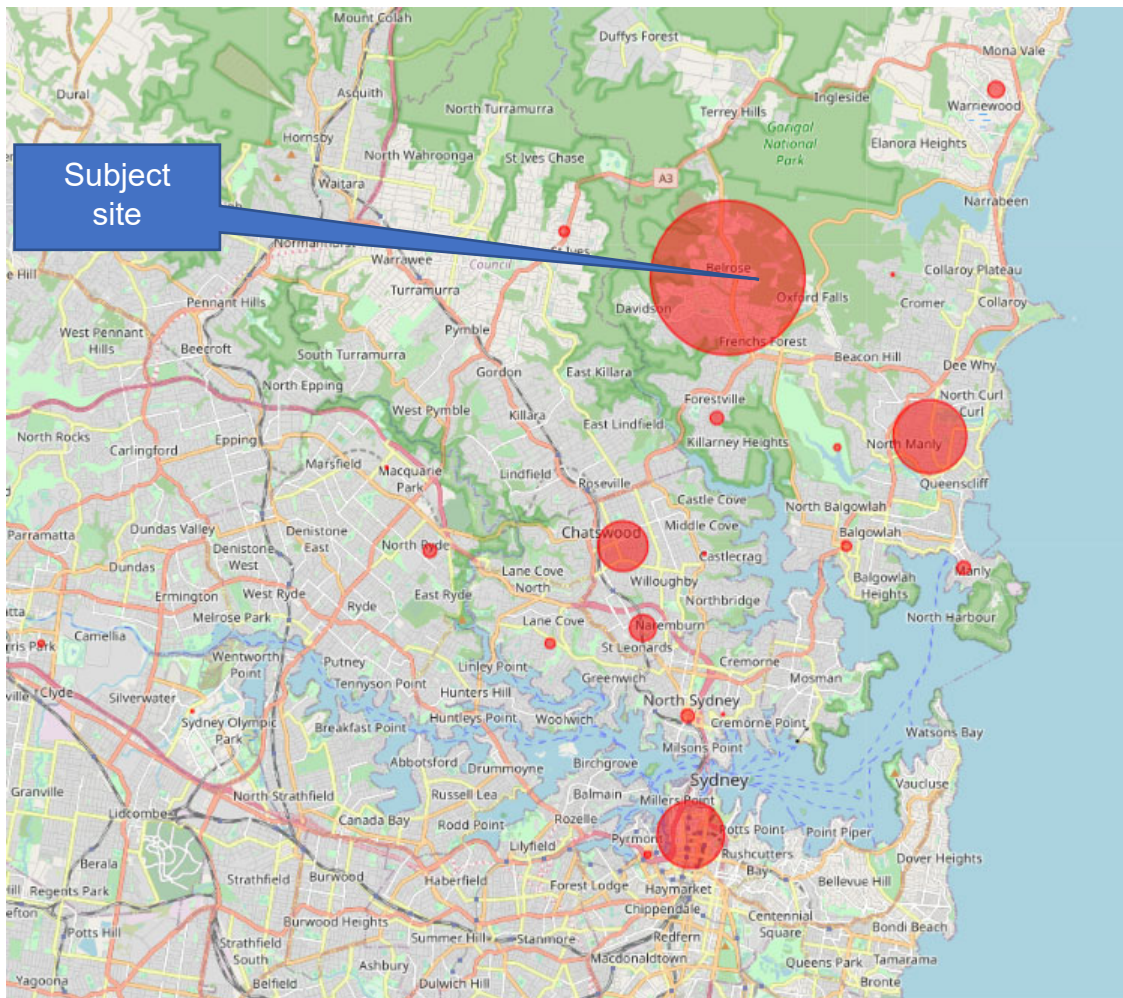

Figure 3 Home location of workers travelling from Belrose

2.2 Road network

To manage the extensive network of roads for which councils are responsible under the Roads Act 1993, Transport for NSW (TfNSW) in partnership with local government established an administrative framework of *State*, *Regional*, and *Local Road* categories. State Roads are managed and financed by TfNSW and Regional and Local Roads are managed and financed by councils.

Regional Roads perform an intermediate function between the main arterial network of State Roads and council controlled Local Roads. Due to their network significance TfNSW provides financial assistance to councils for the management of their Regional Roads. Key State and Regional roads which provide access to the site are illustrated in Figure 4. This demonstrates the site is very well connected to the surrounding State road network, with Forest Way acting as the primary access to the site. Forest Way is classified State road which serves as a major north-south arterial link, providing connectivity between Warringah Road and Mona Vale Road. Warringah Road has recently been upgraded by Transport for NSW around the Frenchs Forest town centre to provide for improved traffic capacity in the Northern Beaches area. The Wakehurst Parkway is also a State classified road which provides connectivity to Oxford Falls Road to the south-east of the site.

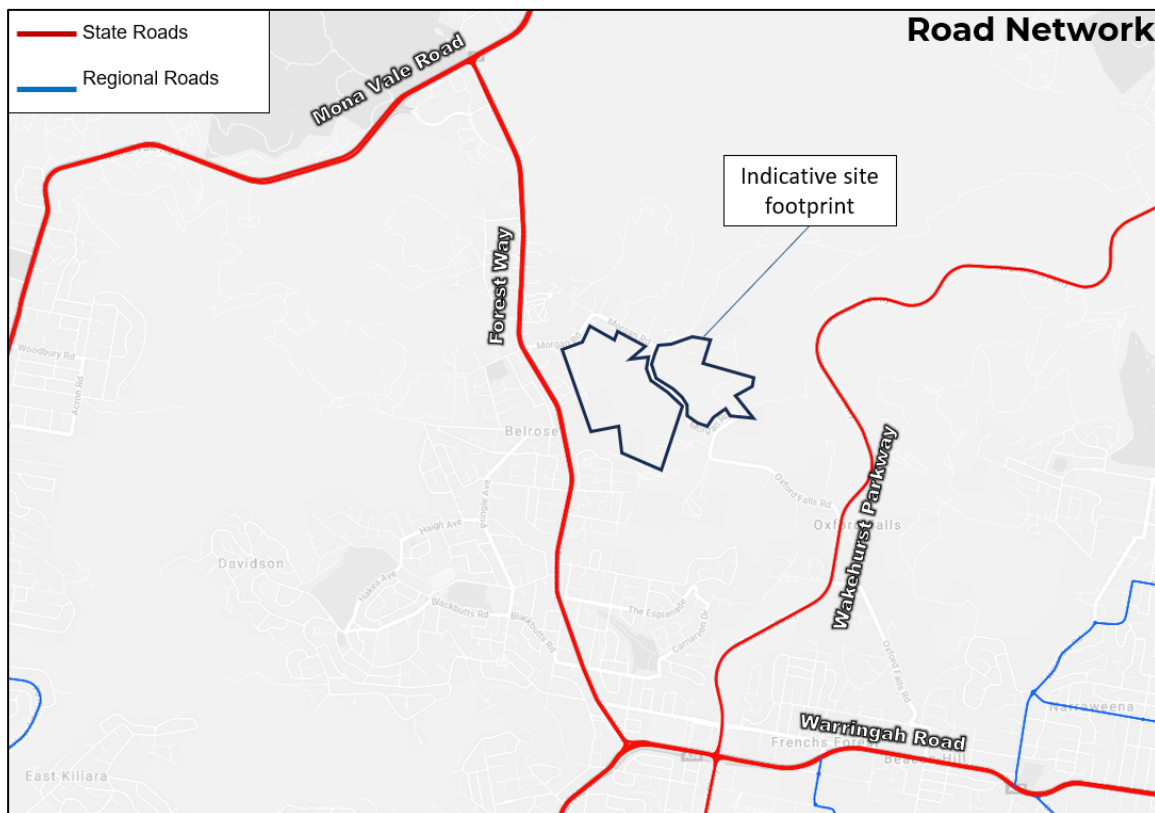

Figure 4 Road network serving the site

Forest Way is a State Classified Road (MR 529) that traverses in a north-south direction between Mona Vale Road in the north and Warringah Road in the south, carrying approximately 40,000 vehicles per day. It is generally subject to 70km/h or 80km/hr speed zoning. Forest Way carries two lanes of traffic as well as one bicycle lane in either direction within a divided carriageway of width 9.5 metres.

Morgan Road is a collector road that runs in an east-west direction to the north and east of the site, carrying approximately 5,000 vehicles per day. It has a posted speed limit of 50 km/h and accommodates a single lane of traffic in either direction within an undivided carriageway. Morgan Road forms a signalised intersection with Forest Way Road with all movements permissible.

Oates Place is a local road that provides a connection to Forest Way and borders the subject site. A priority controlled intersection exists at Oates Place / Forest Way with all traffic movements permissible.

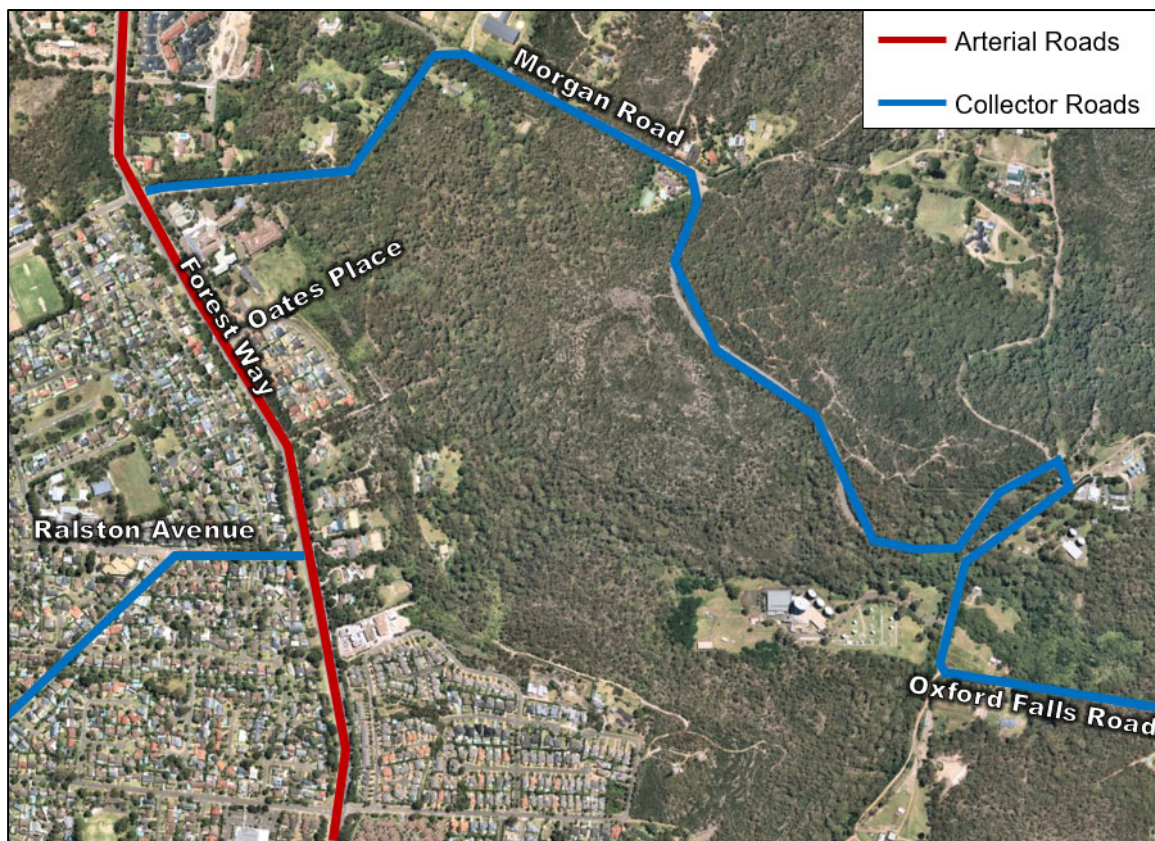

Figure 5 Road hierarchy



Figure 6 Forest Way near Morgan Road



Figure 7 Morgan Road



Figure 8 Oates Place / Forest Way intersection

2.3 Traffic volumes

To inform the preparation of the transport assessment traffic data was collected at the Forest Way / Morgan Road intersection and Wakehurst Parkway / Oxford Falls Road intersection on Thursday 24 August 2023, with results shown in Figure 9 and Figure 10.

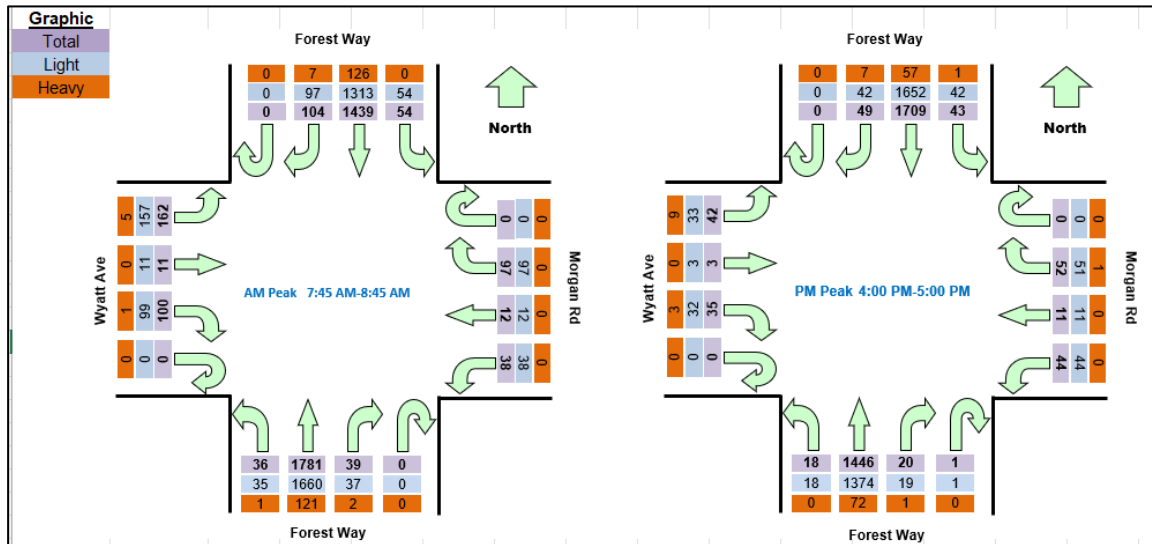

Figure 9 Peak hour traffic flows – Forest Way / Morgan Road

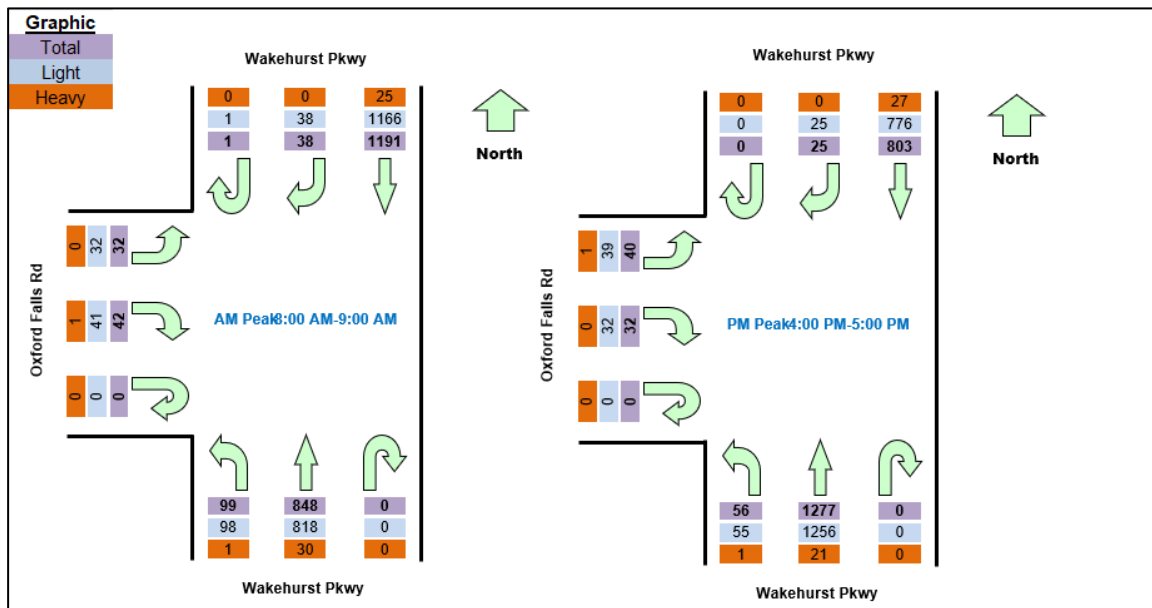

Figure 10 Existing traffic volumes – Wakehurst Parkway / Oxford Falls Road intersection

2.4 Public transport

The existing public transport services that operate in the locality are shown in Figure 11, with the site serviced by the following bus routes:

- 193: Warringah Mall – Austlink (via Frenchs Forest)
- 260: Terry Hills – North Sydney
- 270: Terry Hills – City QVB
- 284: Duffys Forest – Terry Hills
- 271: Belrose – City QVB
- 282: Davidson & Belrose – Chatswood
- 283: Belrose – Chatswood

These bus routes provide for a combined total of approximately 30 bus services during the weekday morning (7am -9am) and afternoon peak (4pm -6pm) periods



Figure 11 Bus network in the vicinity of the site

2.5 Walking and cycling

Some facilities for pedestrians and cyclists are provided around the site, including:

- Footpaths on both sides of Forest Way
- On-road bicycle lane on Forest Way
- Signalised pedestrian crossings at the intersection of Forest Way and Morgan Road.

The above facilities are presented in Figure 12 below.

Generally pedestrian infrastructure outside of Forest Way is limited, with no footpaths currently in place along Morgan Road or through the site itself.



Figure 12 Existing pedestrian and cyclist facilities

3 Concept Plan

The Patyegarang Project Concept Plan provides a vision for the transformation and sensitive development of the site. More than 50% of the site is to be preserved and restored as conservation areas or public open space.

The Concept Plan has been prepared to inform future phases of design and development of the site to promote high quality public, private amenity and good design.

Access to the site will be Morgan Road at the western, northern and eastern boundaries of the site and a new bridge across Snake Creek will provide active transport connections on a daily basis and vehicular egress during a bushfire or emergency.

Neighbourhood amenities will be provided adjoining the aboriginal cultural centre and conservation area and comprise of small shops and cafes.

A network of dedicated active transport links traverse the site through the proposed residential communities and dedicated open space and conservation areas and provide connections to regional trails beyond the site.



Figure 13 Illustrative concept plan

Source: COX Architecture

4 Transport Assessment

4.1 Site access

Key design principles with respect to vehicle site access adopted in the development of the concept plan for the site are as follows:

- No direct access to the site via Forest Way given it's status as a State classified road;
- Provision of a number of access points from Morgan Road to distribute traffic movements across the site;
- No vehicle access via Oates Place (except in the event of a bushfire evacuation); and
- Access points to be designed to accommodate expected traffic flows in accordance with Austroads guidelines – with priority controlled intersections likely to be suitable given the volume of traffic anticipated to be generated by the site development as well as the dispersion of traffic movements across a number of access points

The indicative vehicular access points are shown in Figure 14 below. These will be developed further in subsequent Development Applications lodged for the site.

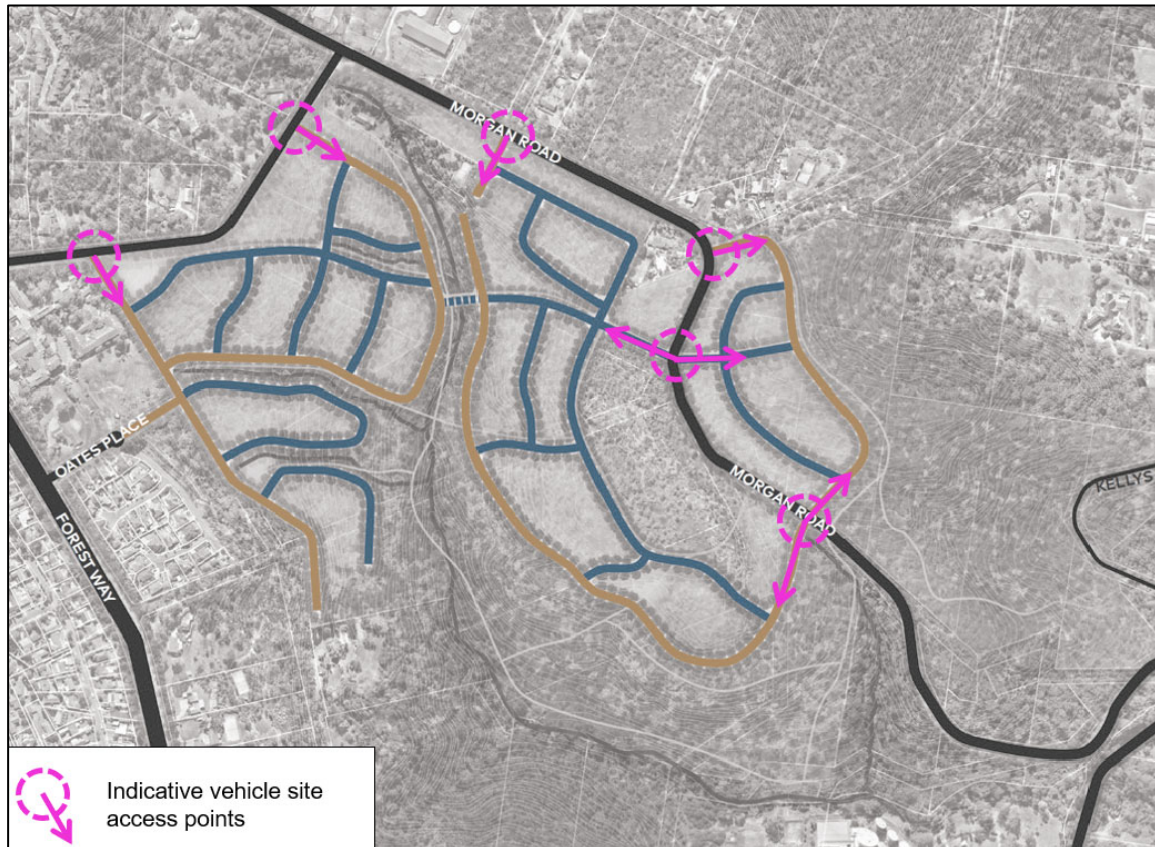

Figure 14 Indicative vehicle site access arrangements

4.2 Internal street network

Key design principles with respect to internal vehicle circulation in the development of the concept plan for the site are as follows:

- New streets and perimeter / fire access trails to generally following existing contour lines to avoid steep slopes and improve vehicle sight lines;
- Provision of an interconnected street network that provides for linkages to the various access points located on Morgan Road;
- Provision of appropriate access and egress for vehicles in a bushfire emergency including a bridge link connecting the eastern and western precincts of the site;
- Egress via Oates Place to Forest Way only provided during an emergency and will not be available for daily traffic movements.
- Street network designed to limit through traffic movements within the site to minimise traffic flows and provide for a safer environment for pedestrians;
- Suitable street cross sections provided to allow for the safe and efficient movement of various vehicle types (including first-responder vehicles) as well as allow for on-street car parking and pedestrian and cycle paths.

The internal street network envisaged as part of the concept plan is illustrated in Figure 15 below.



Figure 15 Indicative internal street network

Source: COX Architecture

4.3 Public transport assessment

As previously noted the site is located adjacent to a number of bus stops servicing seven different bus routes all within walking distance of the site. Planning for the site will focus on providing good quality connections between these bus stops and the site itself.

It is anticipated that travel by bus could ultimately make up approximately 20% of all work related trips from the site – more than double the existing mode share for residents of the area. Based on a conservative estimate of up to 450 dwellings ultimately delivered on the site, this mode share may result in a demand of approximately 200 additional bus trips once the site is fully completed.

Currently 30 bus services operate in peak periods which have the ability to carry approximately 2,000 passengers. Residents from the subject site may ultimately therefore take up just approximately 10% of the total public transport network capacity in the area. Observations around the occupancy of bus services in the area, carried out in early 2022, indicated buses had more than 50% of seats unoccupied. Therefore the existing level of public transport should be sufficient to accommodate future demands from residents – noting any development of the site would take place over a long period of time and be subsequent to separate Development Applications. The suitability of the public transport network, factoring in any changes in supply and demand that have taken place, will be reassessed during the lodgement of these Development Applications.

As shown in Figure 16 the key walking routes to the nearby public transport stops will be via Morgan Road (and its signalised intersection with Forest Way) as well as via the future pedestrian connection through to Oates Place.

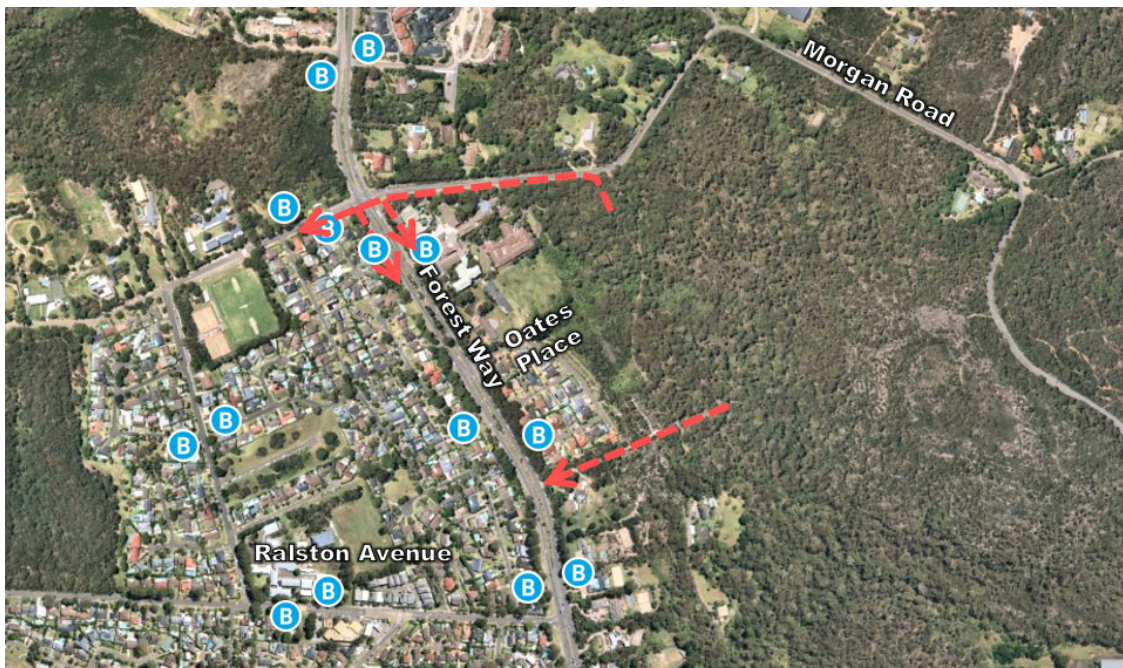

Figure 16 Key walking routes to public transport stops

4.4 Car parking

Car parking arrangements will be detailed in subsequent Development Applications lodged for the site, however key principles developed for the purposes of the Planning Proposal are as follows:

- All dwellings to be provide for on-site car parking in accordance with Council's requirements; and
- Opportunities for visitor car parking (via street parking) to be provided through the design of the internal street network.

4.5 Active transport

Key design principles with respect to active transport in the development of the concept plan for the site are as follows:

- Provision of active and passive walking and cycling networks within the site;
- Formalisation of existing cycling routes through the site;
- Variety of walking and cycling paths to be provided (including shared paths) to accommodate different user groups;
- Walking and cycling routes to be predominantly separated away from vehicle movements;
- Good quality walking and cycling connections from the site to nearby public transport nodes – particularly bus stops along Forest Way; and
- Connections within the site (passive) to focus on Aboriginal cultural heritage focal points.

The indicative set of trails for pedestrians and cyclists within the site are displayed in Figure 17. More detailed provisions for pedestrians and cyclists will be outlined in further detail in subsequent Development Applications to be lodged for the site.



Figure 17 Indicative public walking trails and active transport routes

5 Traffic Analysis

5.1 Traffic generation

The forecast level of traffic generated from the development has been based off the rates outlined in the *RMS Guide to Traffic Generating Developments* (2013 update) document. The rates applicable to low density residential dwellings¹ are as follows:

- AM peak hour (8am – 9am): 0.86 vehicles / dwelling
- PM peak hour (5pm – 6pm): 0.89 vehicles / dwelling

The expected directions of travel for vehicles, based again off guidance within the *RMS Guide to Traffic Generating Developments* document, is as follows:

- AM peak hour: 80% departing, 20% arriving
- PM peak hour: 20% departing, 80% arriving

Based on a conservative estimate that 450 dwellings can be developed within the site, the peak hour traffic generation arising from the full development of the site is summarised in Table 1 below.

Table 1 Forecast traffic generation

Peak Hour	No. of dwellings (maximum)	Traffic Generation Rate	Number of vehicle trips		
			Into site	Out of site	Total
AM Peak Hour (8am – 9am)	450	0.86	77	310	387
PM Peak Hour (5pm – 6pm)	450	0.89	321	80	401

¹ Based on the average trip rate used for low density residential dwellings on the road network for the six Sydney sites surveyed

5.2 Traffic distribution

Based on the journey to work census data previously presented in Section 2.1 of this document the following distribution of traffic on a day to day basis has been assumed:

- 50% of traffic movements out of the site to travel south along Forest Way via Morgan Road;
- 20% of traffic movements out of the site to travel north along Forest Way via Morgan Road;
- 30% of traffic movements out of the site to travel east along Morgan Road and Oxford Falls Road towards the Wakehurst Parkway. This route, specifically the bridge at Oxford Falls, is currently being upgraded by Council to provide for two continuous lanes of traffic in each direction – allowing future users of the site with a good quality travel route east towards the Wakehurst Parkway.

The traffic distribution assumptions are illustrated in Figure 18 below.



Figure 18 Traffic distribution assumptions

5.3 Road infrastructure upgrades

Northern Beaches Council is currently replacing the existing bridge at Morgan Road and Oxford Falls Road West due to its age and condition. Currently vehicles crossing the bridge must give way to each other as there is insufficient width to accommodate simultaneous passing of vehicles (see Figure 19).



Figure 19 Existing bridge on Morgan Road at Oxford Falls

Council has developed a final concept design for a new two-lane vehicle bridge with designated pedestrian access that will improve access and safety in the area. The current 50km speed limit along Oxford Falls Road West and Morgan Road will be retained along with the existing three tonne load limit. The bridge will be designed to AS5100 and can carry emergency vehicles if required. Construction commenced late August 2023 with completion planned for late 2023, weather dependent.

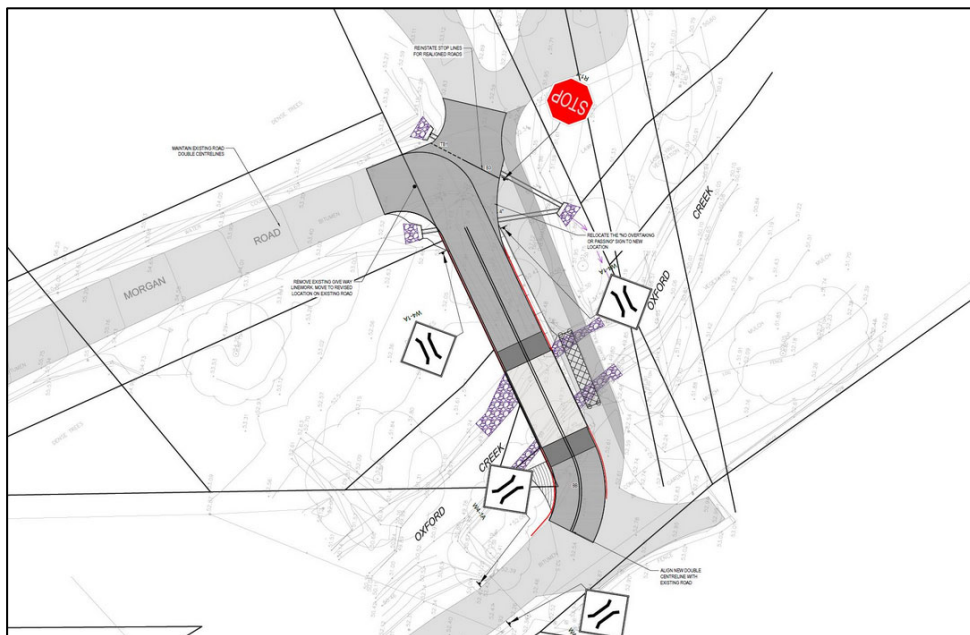

Figure 20 Concept plan for replacement of bridge at Oxford Falls

5.4 Future traffic flows

Based on the traffic generation and distribution assumptions, the additional traffic flows generated by the rezoning of the site can be calculated. These additional traffic movements through the intersections of Forest Way / Morgan Road and Wakehurst Parkway / Oxford Falls Road are shown in Figure 21 and have been used as the basis for the peak hour traffic modelling undertaken for the study.



Figure 21 Forecast additional traffic flows

5.5 Background traffic growth

The Annual Average Daily traffic (AADT) data from the nearest Transport for NSW counting station 57025 which operates on Forest Way immediately south of the site, was extracted from TfNSW's traffic volume viewer to appreciate the pattern of traffic flow changes over recent years. As can be seen in Figure 22 below, traffic flows on Forest Way remained relatively static (and even declined slightly) in the 10 year period between 2009 and 2019. There was a significant reduction in 2020 and 2021 however this is primarily due to the COVID-19 pandemic. As the effects of the pandemic have reduced in 2023 traffic volumes on Forest Way have risen but not to the levels experienced prior to 2020. It could be expected that, with the increasing popularity of working from home, traffic flows on Forest Way would not reach their pre-pandemic levels for some time.

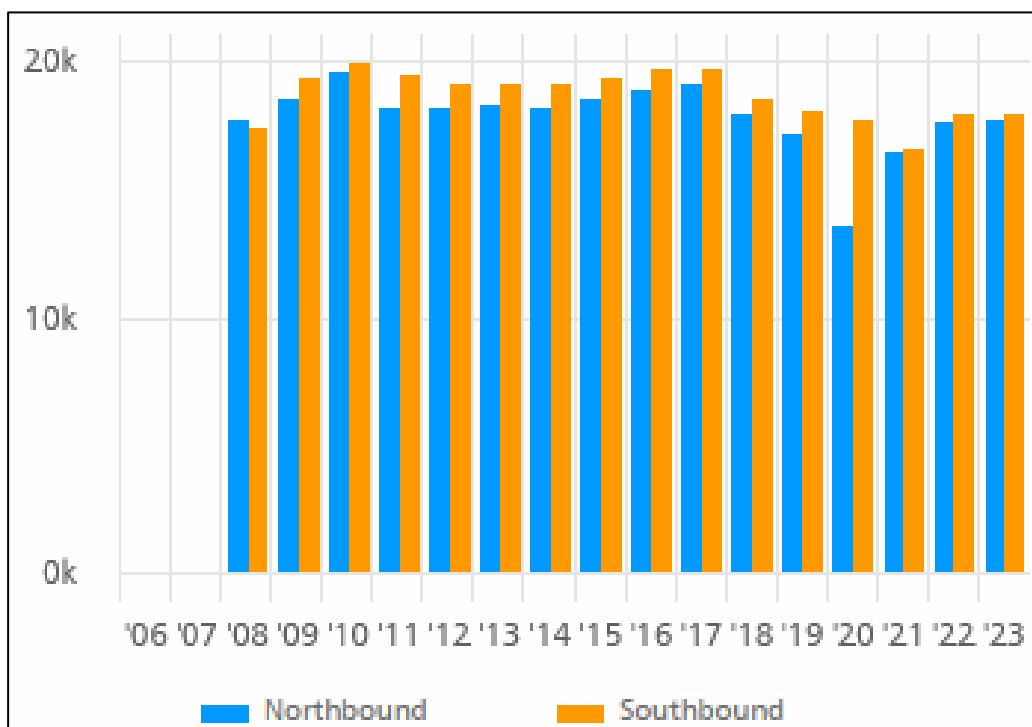

Figure 22 Historical traffic flows – Forest Way (Belrose)

Source: Transport for NSW

Despite the indication of no historical traffic growth on Forest Way in recent times, a 1% growth rate has been applied to traffic movements for the purposes of the modelling undertaken for the Planning Proposal. In light of the review of historical traffic data undertaken this is considered to conservative assumption and therefore provides a robust understanding of the potential future operation of the surrounding road network. Given the nature of the roadway with minimal adjacent development no background traffic growth was applied to the Wakehurst Parkway intersection.

5.6 Traffic modelling

5.6.1 Traffic model calibration

The SIDRA traffic model was calibrated via the use of video footage of the intersection. The video footage was used to calibrate the model in the following ways:

- Traffic light phasing arrangements
- Typical phase and cycle times of the traffic lights
- Vehicle priorities – noting at the Forest Way / Morgan Road intersection left and right turning vehicles from side streets were observed to turn at the same time given the road geometry – see Figure 23
- Extent of typical queues and delays for vehicles turning right from Wakehurst Parkway (southbound) into Oxford Falls Road. Gap acceptance figures in the base model were adjusted based on observations of typical peak hour delays. It was also noted through vehicles on Wakehurst Parkway southbound could pass a stationary vehicle waiting to turn right – see Figure 24



Figure 23 Forest Way / Morgan Road – AM peak hour



Figure 24 Oxford Falls Road / Wakehurst Parkway – PM peak hour

5.6.2 Performance metrics

The performance of intersections in an urban environment is measured in terms of its Level of Service (LoS). Level of service ranges from A (very good) to F (over capacity with significant delays). This is described in the *RTA Guide to Traffic Generating Developments* as summarised in Table 2. In peak hours at intersections controlled by traffic signals on key regional and arterial routes, a LoS D or E is generally considered acceptable.

Table 2 Intersection level of service

Level of Service	Average Vehicle Delay (seconds)	Traffic Signals and Roundabouts	Priority Intersections ('Stop' and "Give Way')
A	< 14	Good operation	Good operation
B	15 to 28	Good with acceptable delays and spare capacity	Acceptable delays and spare capacity
C	29 to 42	Satisfactory	Satisfactory, but accident study required
D	43 to 56	Operating near capacity	Near capacity and accident study required
E	57 to 70	At capacity. At signals, incidents will cause excessive delay. Roundabouts require other control mode	At capacity, requires other control mode
F	> 71	Unsatisfactory with excessive queuing	Unsatisfactory with excessive queuing

5.6.3 Proposed road upgrade

During the development of the concept plan for the site it was identified that safe and efficient vehicle egress from the site would be required during major bushfire events. Given the likely bushfire conditions in this scenario, all traffic would need to be directed to the west to access Forest Way and depart the area. Under current conditions traffic leaving the site via Morgan Road needs to stop at the traffic lights before then turning left onto Forest Way.

In this context an upgrade of the Morgan Road / Forest Way intersection has been identified to facilitate safe and efficient access out of the precinct as indicatively illustrated in Figure 25 below. This involves the creation of a slip lane from Morgan Road onto Forest Way which includes an acceleration lane as per Austroads requirements. This upgrade will allow traffic leaving Morgan Road to bypass the existing traffic lights and enter directly onto Forest Way without delay.

A detailed concept design, including extent of civil and infrastructure works required, has separately been prepared by Craig and Rhodes. The land required to facilitate the upgrade is owned by Council and currently zoned RE1 – making it suitable for the purposes of road widening. Separate traffic modelling for a bushfire emergency evacuation event indicates the upgrade will be required once more than 230 dwellings have been developed and are occupied on the site.



Figure 25 Proposed upgrade to Morgan Road / Forest Way intersection

5.6.4 Intersection performance

The future operation of the Forest Way / Morgan Road intersection has been assessed using SIDRA INTERSECTION 9.1, a computer-based modelling package which assesses intersection performance under prevailing traffic conditions. SIDRA modelling has been undertaken for the following scenarios:

- Scenario 1 – Existing conditions
- Scenario 2 – Existing conditions plus 10 years traffic growth
- Scenario 3 – Existing conditions plus 10 years traffic growth plus proposed rezoning (including new Morgan Road slip lane)

Detailed traffic modelling outputs are provided in Appendix A of this document.

Morgan Road / Forest Way intersection

The traffic modelling results are presented in Table 3 below and demonstrate that the Morgan Road / Forest Way intersection will perform acceptably following the full development of the site at Level of Service C during the AM peak hour and PM peak hour. It should be noted that the analysis undertaken is considered conservative and represents a worst case scenario for the operation of the intersection given that:

- An upper limit development yield of 450 dwellings has been considered in the modelling although the site may ultimately support a yield of between 350 and 450 dwellings; and
- The modelling has considered background traffic growth on Forest Way and surrounding roads, despite investigations showing that traffic flows on Forest Way have remained relatively static (and even declined slightly) over the past decade.

Table 3 Traffic modelling results – Morgan Road / Forest Way

Peak Hour	Existing			Future Base			Future Base + Development		
	AVD (sec)	DOS	LOS	AVD (sec)	DOS	LOS	AVD (sec)	DOS	LOS
AM Peak Hour (8am – 9am)	30	0.83	C	39	0.2	C	40	0.93	C
PM Peak Hour (5pm – 6pm)	21	0.75	B	24	0.83	B	42	0.95	C

AVD – Average vehicle delay DOS – Degree of Saturation LOS – Level of Service

In response to prior discussions with TfNSW in relation to the Planning Proposal specific consideration has been given to the forecast queue length for right turning vehicles on Forest Way (southern approach). As indicated in Figure 26 the maximum queue length is expected to be 38m in the AM peak hour and 83m in the PM peak hour – just exceeding the existing capacity of 80m. In response to this potential impact a mitigation is proposed which would involve extending the existing northbound right turn by approximately 20m. These works could be achieved entirely within the existing road reserve by simply cutting back the current central median on Forest Way. The northbound right turn bay extension would be delivered concurrently with Morgan Road slip lane upgrade.



Figure 26 Forecast maximum queue length for right turning vehicles

Wakehurst Parkway / Oxford Falls Road intersection

The traffic modelling results are presented in Table 3 and demonstrate that the proposal will not adversely impact the operation of the intersection.

Table 4 Traffic modelling results – Wakehurst Parkway / Oxford Falls Road

Peak Hour	Existing			Future Base			Future Base + Development		
	AVD (sec)	DOS	LOS*	AVD (sec)	DOS	LOS*	AVD (sec)	DOS	LOS*
AM Peak Hour (8am – 9am)	2	0.70	B	2	0.70	B	4	0.80	C
PM Peak Hour (5pm – 6pm)	2	0.73	C	2	0.73	C	3	0.77	C

AVD – Average vehicle delay DOS – Degree of Saturation LOS – Level of Service

* Represents level of service for worst approach of intersection

6 Traffic Analysis – Bushfire Evacuation

This section of the report provides an assessment of the ability of the road network to accommodate traffic flows during a major bushfire evacuation event.

6.1 Assumptions for bushfire evacuation

Total yield

Based on work undertaken by Cox Architecture the total development yield considered is 450 residential dwellings. In addition the existing dwellings adjacent to Morgan Road east of Forest Way have been taken into consideration, which number approximately 50 households.

Proportion of dwellings evacuating the precinct

As a highly conservative assumption 100% of all dwellings in the precinct are considered at risk and would be required to evacuate the precinct during a major bushfire event. This is considered a conservative assumption given the development will remove part of vegetated areas which would in turn reduce the number of dwellings at risk, meaning not all of the population would need to evacuate the area and instead could remain in place. As a comparison the bushfire evacuation modelling undertaken for the Ingleside Precinct assumed 25% of residents would 'stay and defend' rather than evacuate.

Vehicles in risk zone

The Vehicles in Risk Zone is the number of vehicles owned by residents of the dwellings at risk. It is calculated by adopting 2 x vehicles per dwellings as per the carparking requirements in the Warringah Council Development Control Plan (DCP) for similar type developments, being $500 \times 2 = 1,000$ vehicles.

Traffic egress routes

During a bushfire evacuation the following traffic egress routes would be available to residents:

- Morgan Road (westbound) via the Morgan Road / Forest Way intersection. This is assumed to be the primary egress route and would accommodate approximately 80% of traffic movements
- Via the Oates Place / Forest Way intersection as a secondary egress route which is used only in the event of a bushfire emergency, assumed to take the remaining 20% of traffic movements

Dwelling occupied on day of fire

The unoccupied number of dwellings as per the 2016 ABS Census data is approximately 10% on any given day (vacant homes, occupants on vacation etc). Therefore, the number of dwellings occupied at any given time is only 90% of the total, which has been applied to the Dwellings at Risk to calculate the 'Dwellings occupied on day of fire', being $500 \times 90\% = 450$ dwellings,

Again, this is conservative as it is highly unlikely that a fire would suddenly threaten the suburb during the night when most people are home. It is likely that it would occur during the day and, most likely late in the day. Therefore, many people will not be home when the fire threatens. Accordingly, the number of dwellings occupied at the time of day that the fire threatens is likely to be considerably less than the number of occupied dwellings on the day of the fire.

Vehicles from risk zone leaving in final hour

A study undertaken analysing behavioural aspects of the 2009 Victoria Bushfires² indicated that 54% of residents evacuated during a bushfire, and of those residents that evacuated 47% left prior to the last hour before the bushfire arrived. Given the site's more urban location, as well as again considering a highly conservative scenario, only 75% of dwellings have been assumed to depart prior to the final hour before the bushfire arriving.

Traffic volumes on adjacent road network

Another highly conservative assumption made as part of this analysis is that traffic volumes on the adjacent road network (i.e. through the Morgan Road / Forest Way intersection) will not be impacted by the bushfire event. Further, the traffic modelling has considered the busiest hour of the day on the road network, that being the afternoon (5pm – 6pm) commuter peak hours period as previously described in Section 0 of this document.

During a major bushfire event it has been assumed no external traffic would be able to enter or exit from Morgan Road, apart from those vehicles already within the area.

² Bushfire Cooperative Research Centre, 2009

6.2 Traffic demands during bushfire evacuation

The table below indicates the traffic demands on the road network (including adjacent properties on Morgan Road) during a bushfire evacuation event.

Table 5 Forecast traffic demands (bushfire evacuation)

Metric	Quantum
Dwelling yield (Patyegarang Project + Existing properties on Morgan Road)	500
% of dwellings at risk	100%
% of dwellings that evacuate	100%
% of dwellings occupied at time of bushfire	90%
Number of dwellings evacuating	450
Number of cars per dwelling	2.00
Total vehicles evacuating	900
% of dwellings that leave in the hour before the bushfire arrives	75%
Traffic demands during bushfire evacuation (peak hour)	675
Traffic demands - Oates Place / Forest Way	135
Traffic demands - Morgan Road / Forest Way	540

6.3 Road network performance during bushfire emergency

The ability of the road network to accommodate additional traffic flows during a major bushfire event has been assessed. SIDRA modelling has been undertaken at the Forest Way / Morgan Road intersection which considers existing traffic movements, background traffic growth and traffic movements generated by the rezoning. The modelling takes into consideration the upgrade of the intersection through a new slip lane as summarised in Section 5.6.3 of this document. The traffic modelling has considered the performance of the specific traffic movement from Morgan Road onto Forest Way, which is critical with respect to bushfire evacuation.

The modelling has utilised the following inputs:

- Traffic movements during the busiest hour of the day (5pm – 6pm) representing the commuter PM peak hour, as previously detailed in Section 2.3 of this document.
- Expected traffic growth over a 10 year period.
- Traffic demands generated by the site and turning left at the Forest Way / Morgan Road intersection (see Section 6.2)

The findings of the traffic modelling are summarised in Table 6 below.

Table 6 Traffic modelling results - bushfire evacuation scenario

Scenario	Left turn from Morgan Road to Forest Way			
	AVD (sec)	DOS	LOS	Max. queue length
Existing intersection configuration	88	0.93	F	296m
Proposed upgraded intersection with slip lane	15	0.31	B	0m

AVD – Average vehicle delay (seconds) DOS – Degree of Saturation LOS – Level of Service

Without the slip lane in place (i.e. under the current intersection configuration) vehicles attempting to egress the site from Morgan Road will experience a Level of Service ‘F’ with delays nearly 90 seconds and a queue length of almost 300m. These result therefore triggers the requirement to implement upgrades in the form of the slip lane.

The introduction of the slip lane as proposed allows a free flow of traffic from Morgan Road onto Forest Way, with no queues expected to form. The slip lane provides enough capacity for the evacuating vehicles to turn left onto Forest Way, as well as spare capacity to accommodate vehicles external to the proposed site travelling along Morgan Road.

It is also important to note that the modelling has adopted a number of highly conservative assumptions as outlined in Section 6.1 of this document. Therefore the performance results presented represent a worst case scenario, with traffic performance to further improve under a more realistic scenario in terms of bushfire evacuation conditions.

6.4 Sensitivity analysis

A sensitivity analysis has been undertaken to determine the trigger point for the introduction of the future slip lane from Morgan Road onto Forest Way. A similar traffic modelling approach was undertaken to that detailed in the previous sections of this report, with the number of dwellings on the site reduced to provide for an acceptable road network outcome during a bushfire evacuation event that relies on the existing intersection remaining unchanged.

The parameter used for understanding the trigger point for the slip lane was the maximum queue length on Morgan Road. A queue length of more than 90m on Morgan Road represents approximately 14 vehicles queued at any one time. Based on the typical phase length of 27 seconds – 30 seconds any more than a 14 vehicle queue would result in a residual queue at the end of the phase – i.e. not all traffic being able to turn left in a single phase.

The analysis has indicated that a yield of approximately 200 dwellings on the site would result in a vehicle queue just short of 90m on Morgan Road. Therefore the identified trigger point for the installation of the slip lane on Morgan Road is 200 residential dwellings. It would be at this time that the 20m northbound right turn bay extension on Forest Way would be delivered.

Traffic modelling outputs are provided in Appendix A of this document.

7 Summary

This transport assessment report has been prepared by JMT Consulting to support a Planning Proposal for the 'Patyegarang Project' site in Belrose, NSW. The Planning Proposal would allow for residential uses on the existing 35ha site, with the initial concept plan contemplating the site may ultimately support between 350 and 450 dwellings.

Key findings from the transport assessment are as follows:

- The surrounding road network, including Forest Way and the signalised intersection of Morgan Road / Forest Way can accommodate the expected level of day to day traffic generated under the rezoning proposal.
- The project would deliver upgrades to the road network to improve traffic capacity for both site users and the general public, including:
 - Introduction a new slip lane from Morgan Road into Forest Way; and
 - Extension by 20m of the northbound right turn bay from Forest Way into Morgan Road
- Egress in a bushfire evacuation scenario can be accommodated safely pending the installation of the slip lane from Morgan Road into Forest Way. This upgrade is required following the development of 200 or more dwellings on the site.
- Suitable site access arrangements can be provided along Morgan Road with multiple accesses envisaged to distribute traffic movements across the site. No direct vehicle access would be provided from Forest Way given it's function as a State classified road.
- The internal street network will be designed to limit through traffic movements within the site, accommodate movement of pedestrians and cyclists and allow for the safe and efficient movement of various vehicle types (including first-responder vehicles).
- The Planning Proposal would facilitate the formalisation of existing cycling routes through the site and well as provide good quality pedestrian connections through to nearby public transport stops on Forest Way.

Appendix A: Traffic Modelling Outputs

SITE LAYOUT

Site: 101 [AM Existing (Site Folder: Forest Way / Morgan Road - Typical Day)]

Forest Way / Morgan Road

Site Category: (None)

Signals - EQUISAT (Fixed-Time/SCATS) Isolated

Layout pictures are schematic functional drawings reflecting input data. They are not design drawings.

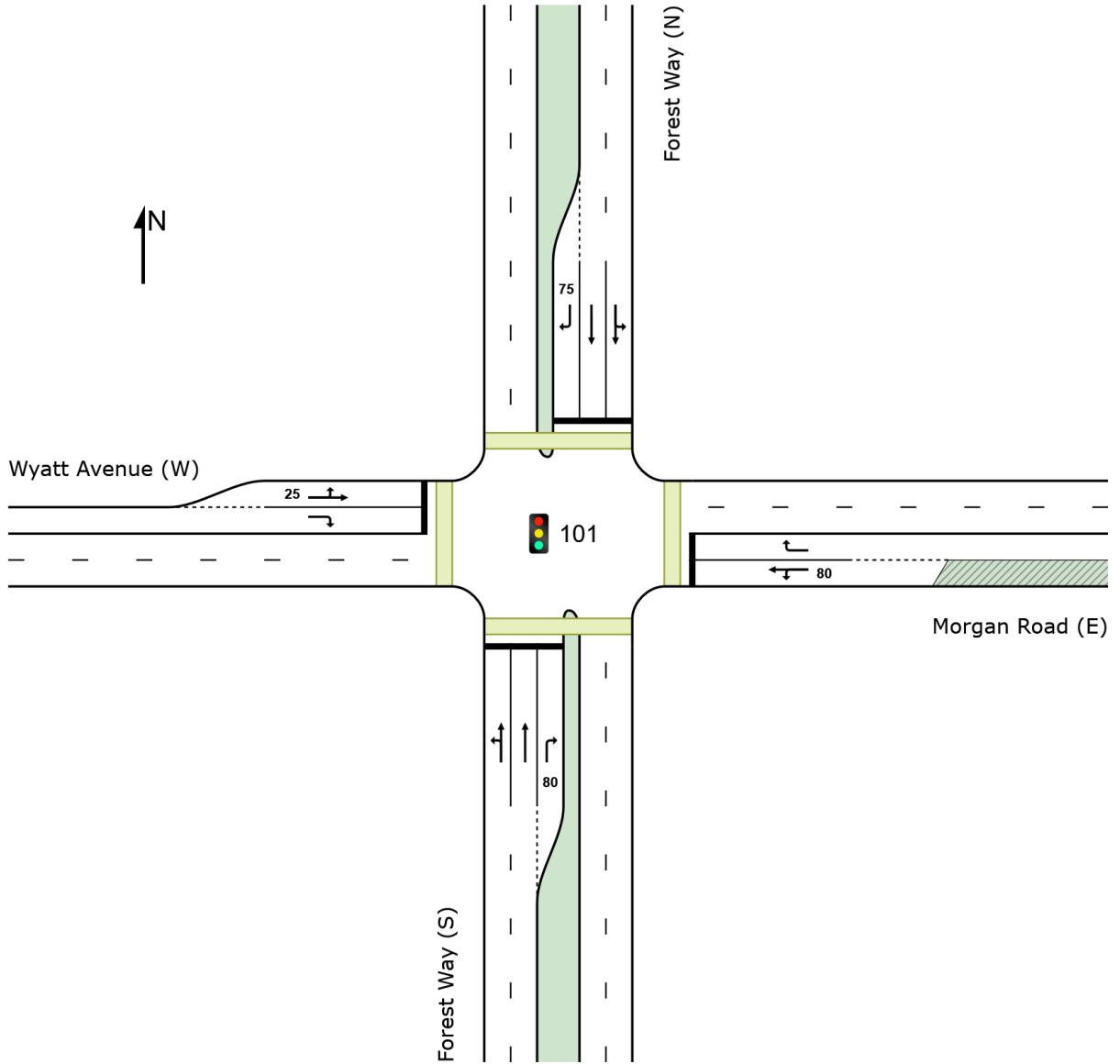

MOVEMENT SUMMARY

Site: 101 [AM Existing (Site Folder: Forest Way / Morgan Road - Typical Day)]

Output produced by SIDRA INTERSECTION Version: 9.1.1.200

Forest Way / Morgan Road

Site Category: (None)

Signals - EQUISAT (Fixed-Time/SCATS) Isolated Cycle Time = 130 seconds (Site User-Given Cycle Time)

Variable Sequence Analysis applied. The results are given for the selected output sequence.

Vehicle Movement Performance															
Mov ID	Turn	Mov Class	Demand Flows		Arrival Flows		Deg. Satn	Aver. Delay	Level of Service	95% Back Of Queue		Prop. Que	Eff. Stop Rate	Aver. No. of Cycles	Aver. Speed
			[Total HV]	[Total HV]	[Total HV]	[Total HV]				[Veh.]	[Dist]				
			veh/h	%	veh/h	%	v/c	sec		veh	m				km/h
South: Forest Way (S)															
1	L2	All MCs	38	2.8	38	2.8	0.833	26.7	LOS B	47.3	350.0	0.85	0.79	0.85	47.4
2	T1	All MCs	1875	6.8	1875	6.8	*0.833	26.0	LOS B	47.3	350.0	0.85	0.79	0.85	50.3
3	R2	All MCs	41	5.1	41	5.1	0.298	81.4	LOS F	2.6	18.8	0.98	0.74	0.98	28.8
Approach			1954	6.7	1954	6.7	0.833	27.1	LOS B	47.3	350.0	0.86	0.78	0.86	49.5
East: Morgan Road (E)															
4	L2	All MCs	40	0.0	40	0.0	0.138	47.8	LOS D	2.7	19.0	0.85	0.72	0.85	34.6
5	T1	All MCs	13	0.0	13	0.0	0.138	57.0	LOS E	2.7	19.0	0.85	0.72	0.85	35.8
6	R2	All MCs	102	0.0	102	0.0	0.422	60.6	LOS E	6.0	41.8	0.95	0.79	0.95	31.6
Approach			155	0.0	155	0.0	0.422	57.0	LOS E	6.0	41.8	0.91	0.77	0.91	32.6
North: Forest Way (N)															
7	L2	All MCs	57	0.0	57	0.0	0.704	23.8	LOS B	33.9	253.7	0.73	0.68	0.73	49.7
8	T1	All MCs	1515	8.8	1515	8.8	0.704	21.0	LOS B	33.9	253.7	0.73	0.68	0.73	52.3
9	R2	All MCs	109	6.7	109	6.7	*0.803	84.4	LOS F	7.5	55.5	1.00	0.90	1.23	27.1
Approach			1681	8.3	1681	8.3	0.803	25.2	LOS B	33.9	253.7	0.75	0.69	0.76	49.3
West: Wyatt Avenue (W)															
10	L2	All MCs	171	3.1	171	3.1	0.493	63.7	LOS E	9.8	70.4	0.90	0.80	0.90	34.4
11	T1	All MCs	12	0.0	12	0.0	*0.493	73.4	LOS F	9.8	70.4	0.90	0.80	0.90	35.8
12	R2	All MCs	105	1.0	105	1.0	0.435	75.3	LOS F	6.2	43.6	0.95	0.79	0.95	31.5
Approach			287	2.2	287	2.2	0.493	68.4	LOS E	9.8	70.4	0.92	0.80	0.92	33.3
All Vehicles			4077	6.8	4077	6.8	0.833	30.4	LOS C	47.3	350.0	0.82	0.75	0.82	46.9

Site Level of Service (LOS) Method: Delay (RTA NSW). Site LOS Method is specified in the Parameter Settings dialog (Options tab).

Vehicle movement LOS values are based on average delay per movement.

Intersection and Approach LOS values are based on average delay for all vehicle movements.

Delay Model: SIDRA Standard (Control Delay: Geometric Delay is included).

Queue Model: SIDRA queue estimation methods are used for Back of Queue and Queue at Start of Green.

Gap-Acceptance Capacity Formula: SIDRA Standard (Akçelik M3D).

HV (%) values are calculated for All Movement Classes of All Heavy Vehicle Model Designation.

Arrival Flows used in performance calculations are adjusted to include any Initial Queued Demand and Upstream Capacity Constraint effects.

* Critical Movement (Signal Timing)

Pedestrian Movement Performance												
Mov ID	Crossing	Input Vol.	Dem. Flow	Aver. Delay	Level of Service	AVERAGE BACK OF QUEUE		Prop. Que	Eff. Stop Rate	Travel Time	Travel Dist.	Aver. Speed
						[Ped]	[Dist]					
		ped/h	ped/h	sec		ped	m			sec	m	m/sec
South: Forest Way (S)												
P1	Full	6	6	59.2	LOS E	0.0	0.0	0.95	0.95	225.8	200.0	0.89

East: Morgan Road (E)												
P2	Full	3	3	59.1	LOS E	0.0	0.0	0.95	0.95	225.8	200.0	0.89
North: Forest Way (N)												
P3	Full	6	6	59.2	LOS E	0.0	0.0	0.95	0.95	225.8	200.0	0.89
West: Wyatt Avenue (W)												
P4	Full	3	3	59.1	LOS E	0.0	0.0	0.95	0.95	225.8	200.0	0.89
All	Pedestrians	18	19	59.2	LOS E	0.0	0.0	0.95	0.95	225.8	200.0	0.89

Level of Service (LOS) Method: SIDRA Pedestrian LOS Method (Based on Average Delay)

Pedestrian movement LOS values are based on average delay per pedestrian movement.

Intersection LOS value for Pedestrians is based on average delay for all pedestrian movements.

SIDRA INTERSECTION 9.1 | Copyright © 2000-2022 Akcelik and Associates Pty Ltd | sidrasolutions.com
 Organisation: JMT CONSULTING | Licence: NETWORK / 1PC | Processed: Monday, 4 September 2023 8:01:29 PM
 Project: C:\JMT Consulting\Projects\2046 - Belrose PP\Internal\Belrose SIDRA_Updated Aug23.sip9

PHASING SUMMARY

Site: 101 [AM Existing (Site Folder: Forest Way / Morgan Road - Typical Day)]

Output produced by SIDRA INTERSECTION Version: 9.1.1.200

Forest Way / Morgan Road

Site Category: (None)

Signals - EQUISAT (Fixed-Time/SCATS) Isolated Cycle Time = 130 seconds (Site User-Given Cycle Time)

Variable Sequence Analysis applied. The results are given for the selected output sequence.

Timings based on settings in the Site Phasing & Timing dialog

Phase Times determined by the program

Phase Sequence: Leading Right Turn

Input Phase Sequence: A, B, B1*, B2*, C

Output Phase Sequence: A, B, C

Reference Phase: Phase B

(* Variable Phase)

Phase Timing Summary

Phase	A	B	C
Phase Change Time (sec)	114	0	87
Green Time (sec)	10	81	21
Phase Time (sec)	16	87	27
Phase Split	12%	67%	21%
Phase Frequency (%)	100.0 ⁴	100.0 ⁴	100.0 ⁴

See the Timing Analysis report for more detailed information including input values of Yellow Time and All-Red Time, and information on any adjustments to Intergreen Time, Phase Time and Green Time values in cases of Pedestrian Actuation, Minor Phase Actuation and Phase Frequency values (user-specified or implied) less than 100%.

⁴ Phase Frequency specified by the user (phase times not specified).

Output Phase Sequence

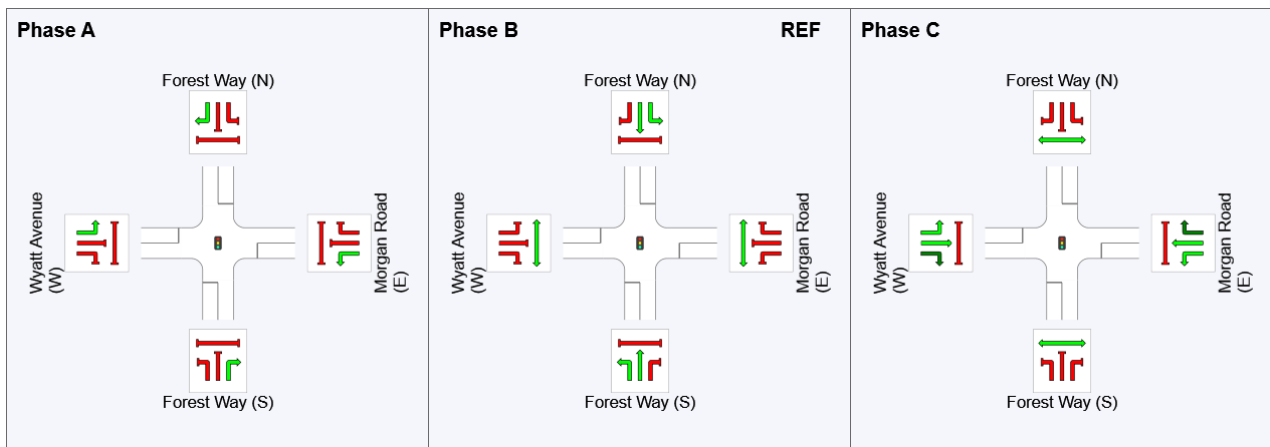

REF: Reference Phase

VAR: Variable Phase

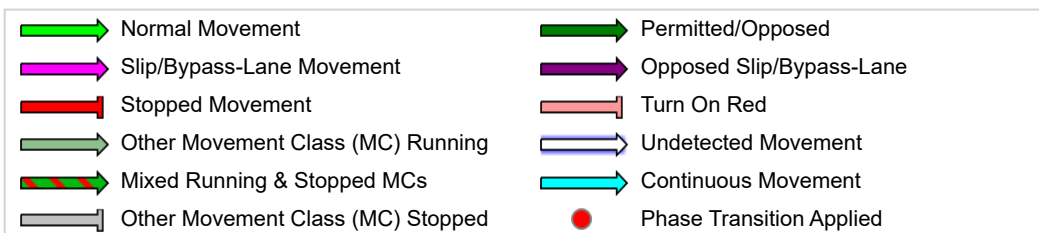

SITE LAYOUT

Site: 101 [AM FutureBase (Site Folder: Forest Way / Morgan Road - Typical Day)]

Forest Way / Morgan Road

Site Category: (None)

Signals - EQUISAT (Fixed-Time/SCATS) Isolated

Layout pictures are schematic functional drawings reflecting input data. They are not design drawings.

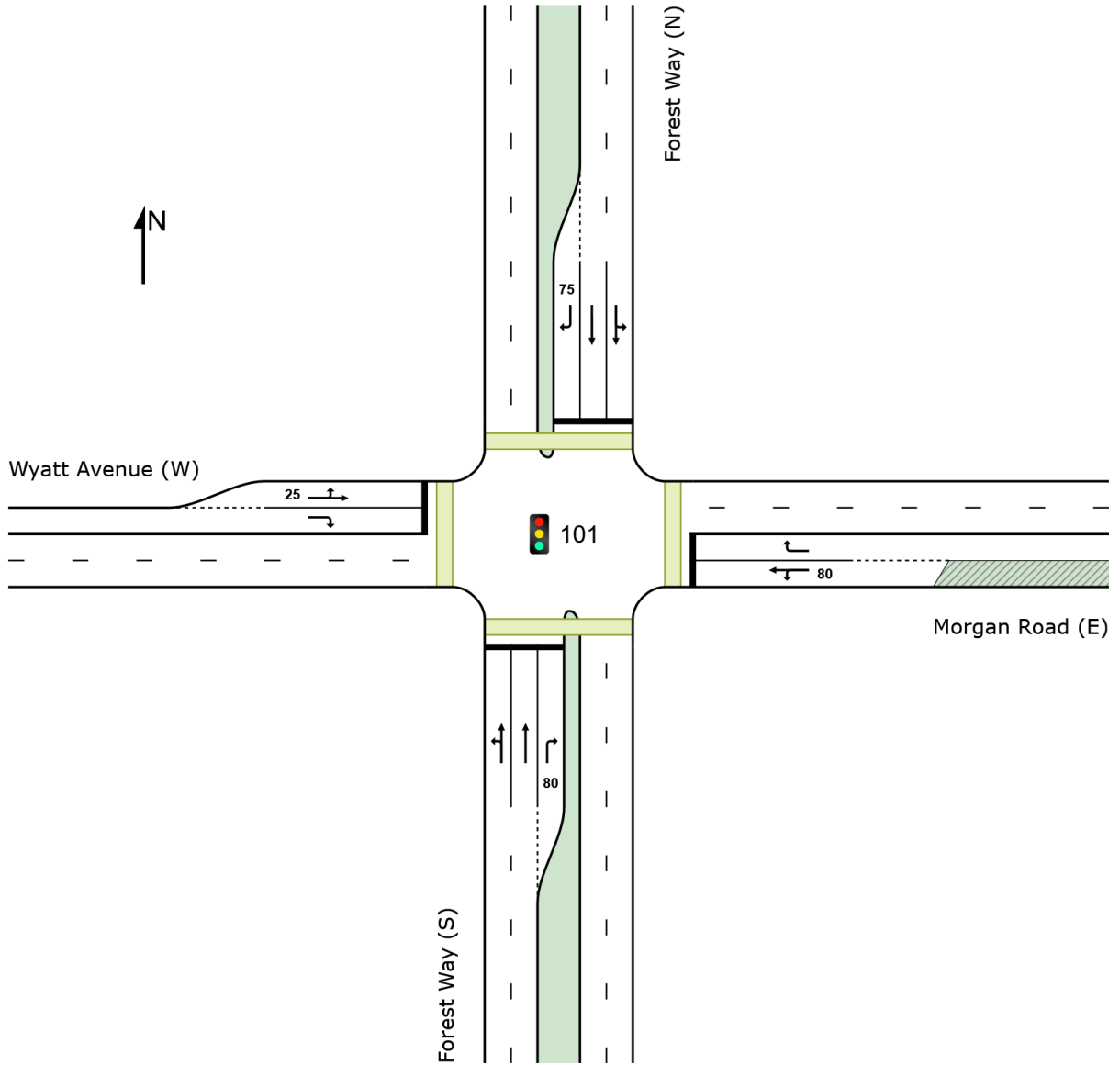

MOVEMENT SUMMARY

Site: 101 [AM FutureBase (Site Folder: Forest Way / Morgan Road - Typical Day)]

Output produced by SIDRA INTERSECTION Version: 9.1.1.200

Forest Way / Morgan Road

Site Category: (None)

Signals - EQUISAT (Fixed-Time/SCATS) Isolated Cycle Time = 130 seconds (Site User-Given Cycle Time)

Variable Sequence Analysis applied. The results are given for the selected output sequence.

Vehicle Movement Performance															
Mov ID	Turn	Mov Class	Demand Flows		Arrival Flows		Deg. Satn	Aver. Delay	Level of Service	95% Back Of Queue		Prop. Que	Eff. Stop Rate	Aver. No. of Cycles	Aver. Speed
			[Total HV]	%	[Total HV]	%	v/c	sec		[Veh.]	[Dist]				km/h
			veh/h		veh/h					veh	m				
South: Forest Way (S)															
1	L2	All MCs	42	2.5	42	2.5	0.918	39.8	LOS C	67.0	495.5	0.96	0.95	1.05	40.6
2	T1	All MCs	2064	6.7	2064	6.7	*0.918	40.9	LOS C	67.0	495.5	0.96	0.95	1.05	42.5
3	R2	All MCs	45	4.7	45	4.7	0.327	84.6	LOS F	2.8	20.7	0.98	0.74	0.98	28.8
Approach			2152	6.6	2152	6.6	0.918	41.8	LOS C	67.0	495.5	0.96	0.95	1.05	42.0
East: Morgan Road (E)															
4	L2	All MCs	44	0.0	44	0.0	0.151	48.0	LOS D	3.0	21.0	0.86	0.73	0.86	34.6
5	T1	All MCs	14	0.0	14	0.0	0.151	57.2	LOS E	3.0	21.0	0.86	0.73	0.86	35.7
6	R2	All MCs	113	0.0	113	0.0	0.469	61.1	LOS E	6.7	46.6	0.95	0.80	0.95	31.4
Approach			171	0.0	171	0.0	0.469	57.4	LOS E	6.7	46.6	0.92	0.77	0.92	32.5
North: Forest Way (N)															
7	L2	All MCs	62	0.0	62	0.0	0.779	25.3	LOS B	40.9	306.5	0.80	0.74	0.80	48.7
8	T1	All MCs	1666	8.7	1666	8.7	0.779	23.6	LOS B	40.9	306.5	0.80	0.74	0.80	51.2
9	R2	All MCs	120	7.0	120	7.0	*0.882	91.7	LOS F	8.6	63.8	1.00	0.96	1.36	26.1
Approach			1848	8.3	1848	8.3	0.882	28.1	LOS B	40.9	306.5	0.81	0.75	0.83	48.1
West: Wyatt Avenue (W)															
10	L2	All MCs	187	2.8	187	2.8	0.562	67.6	LOS E	11.0	78.8	0.92	0.81	0.92	34.1
11	T1	All MCs	13	0.0	13	0.0	*0.562	77.6	LOS F	11.0	78.8	0.92	0.81	0.92	35.5
12	R2	All MCs	117	0.9	117	0.9	0.535	79.2	LOS F	7.0	49.3	0.97	0.80	0.97	31.2
Approach			317	2.0	317	2.0	0.562	72.3	LOS F	11.0	78.8	0.94	0.81	0.94	33.0
All Vehicles			4487	6.7	4487	6.7	0.918	38.9	LOS C	67.0	495.5	0.90	0.85	0.95	42.9

Site Level of Service (LOS) Method: Delay (RTA NSW). Site LOS Method is specified in the Parameter Settings dialog (Options tab).

Vehicle movement LOS values are based on average delay per movement.

Intersection and Approach LOS values are based on average delay for all vehicle movements.

Delay Model: SIDRA Standard (Control Delay: Geometric Delay is included).

Queue Model: SIDRA queue estimation methods are used for Back of Queue and Queue at Start of Green.

Gap-Acceptance Capacity Formula: SIDRA Standard (Akçelik M3D).

HV (%) values are calculated for All Movement Classes of All Heavy Vehicle Model Designation.

Arrival Flows used in performance calculations are adjusted to include any Initial Queued Demand and Upstream Capacity Constraint effects.

* Critical Movement (Signal Timing)

Pedestrian Movement Performance												
Mov ID	Input Crossing	Dem. Flow	Aver. Delay	Level of Service	AVERAGE BACK OF QUEUE		Prop. Que	Eff. Stop Rate	Travel Time	Travel Dist.	Aver. Speed	
	ped/h	ped/h	sec		[Ped]	[Dist]			sec	m	m/sec	
					ped	m						
South: Forest Way (S)												
P1	Full	6	6	59.2	LOS E	0.0	0.0	0.95	0.95	225.8	200.0	0.89

East: Morgan Road (E)												
P2	Full	3	3	59.1	LOS E	0.0	0.0	0.95	0.95	225.8	200.0	0.89
North: Forest Way (N)												
P3	Full	6	6	59.2	LOS E	0.0	0.0	0.95	0.95	225.8	200.0	0.89
West: Wyatt Avenue (W)												
P4	Full	3	3	59.1	LOS E	0.0	0.0	0.95	0.95	225.8	200.0	0.89
All	Pedestrians	18	19	59.2	LOS E	0.0	0.0	0.95	0.95	225.8	200.0	0.89

Level of Service (LOS) Method: SIDRA Pedestrian LOS Method (Based on Average Delay)

Pedestrian movement LOS values are based on average delay per pedestrian movement.

Intersection LOS value for Pedestrians is based on average delay for all pedestrian movements.

SIDRA INTERSECTION 9.1 | Copyright © 2000-2022 Akcelik and Associates Pty Ltd | sidrasolutions.com
 Organisation: JMT CONSULTING | Licence: NETWORK / 1PC | Processed: Monday, 4 September 2023 8:01:54 PM
 Project: C:\JMT Consulting\Projects\2046 - Belrose PP\Internal\Belrose SIDRA_Updated Aug23.sip9

PHASING SUMMARY

Site: 101 [AM FutureBase (Site Folder: Forest Way / Morgan Road - Typical Day)]

Output produced by SIDRA INTERSECTION Version: 9.1.1.200

Forest Way / Morgan Road

Site Category: (None)

Signals - EQUISAT (Fixed-Time/SCATS) Isolated Cycle Time = 130 seconds (Site User-Given Cycle Time)

Variable Sequence Analysis applied. The results are given for the selected output sequence.

Timings based on settings in the Site Phasing & Timing dialog

Phase Times determined by the program

Phase Sequence: Leading Right Turn

Input Phase Sequence: A, B, B1*, B2*, C

Output Phase Sequence: A, B, C

Reference Phase: Phase B

(* Variable Phase)

Phase Timing Summary

Phase	A	B	C
Phase Change Time (sec)	114	0	87
Green Time (sec)	10	81	21
Phase Time (sec)	16	87	27
Phase Split	12%	67%	21%
Phase Frequency (%)	100.0 ⁴	100.0 ⁴	100.0 ⁴

See the Timing Analysis report for more detailed information including input values of Yellow Time and All-Red Time, and information on any adjustments to Intergreen Time, Phase Time and Green Time values in cases of Pedestrian Actuation, Minor Phase Actuation and Phase Frequency values (user-specified or implied) less than 100%.

⁴ Phase Frequency specified by the user (phase times not specified).

Output Phase Sequence

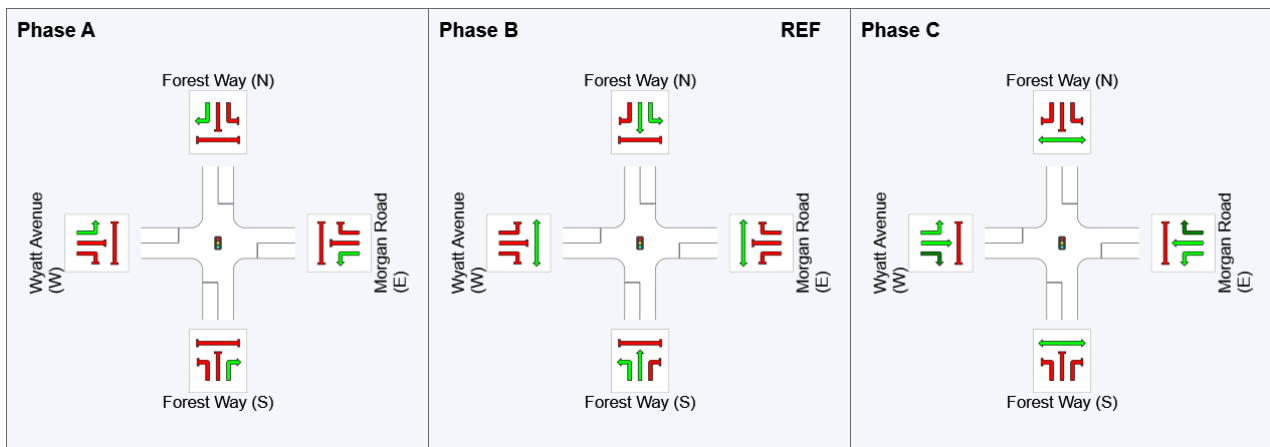

REF: Reference Phase

VAR: Variable Phase



SITE LAYOUT

 Site: 101 [AM FutureBase + Proposal + Slip Lane (Site Folder: Forest Way / Morgan Road - Typical Day)]

Forest Way / Morgan Road

Site Category: (None)

Signals - EQUISAT (Fixed-Time/SCATS) Isolated

Layout pictures are schematic functional drawings reflecting input data. They are not design drawings.

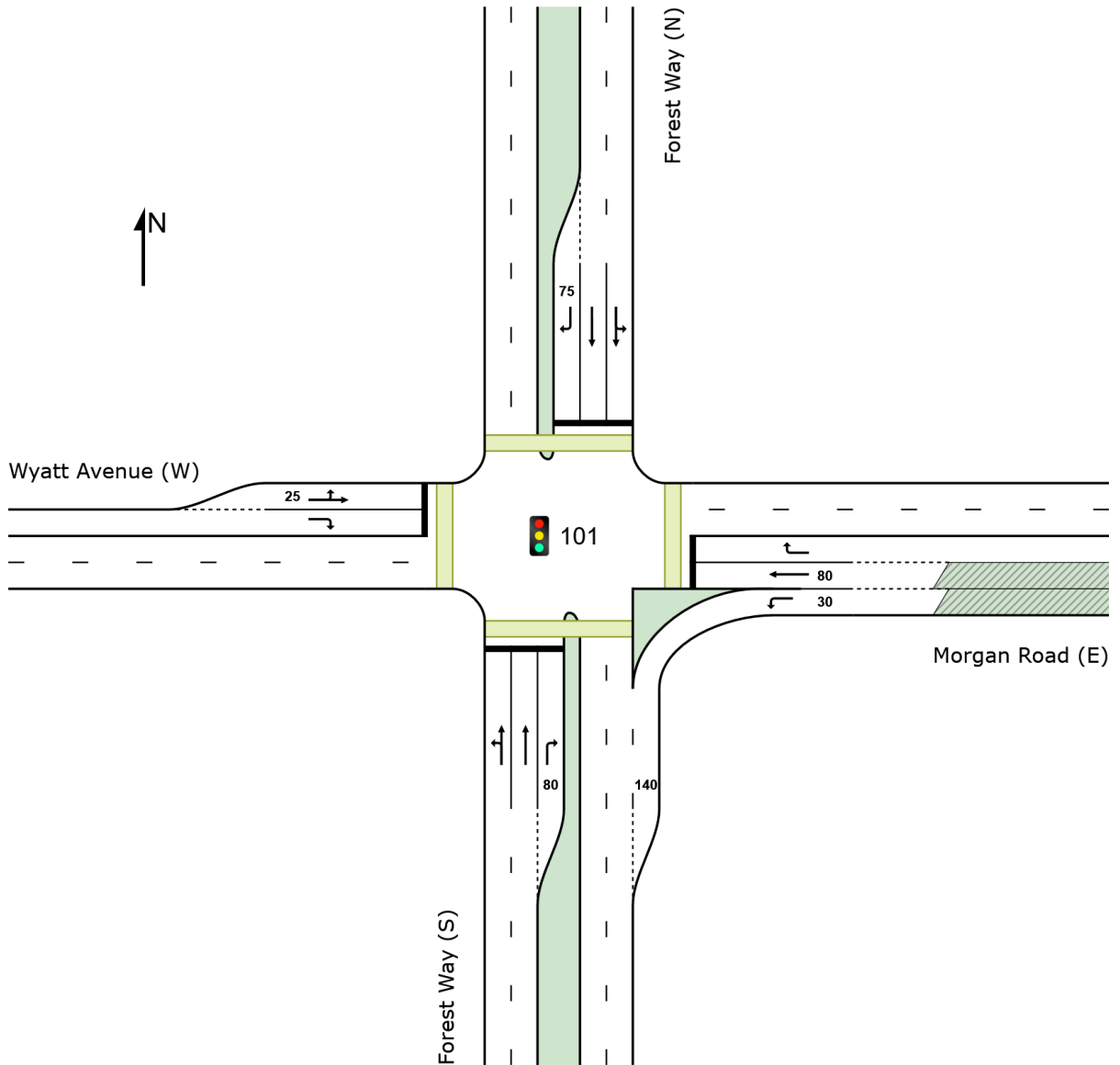

MOVEMENT SUMMARY

Site: 101 [AM FutureBase + Proposal + Slip Lane (Site Folder: Forest Way / Morgan Road - Typical Day)]

Output produced by SIDRA INTERSECTION Version: 9.1.1.200

Forest Way / Morgan Road

Site Category: (None)

Signals - EQUISAT (Fixed-Time/SCATS) Isolated Cycle Time = 130 seconds (Site User-Given Cycle Time)

Variable Sequence Analysis applied. The results are given for the selected output sequence.

Vehicle Movement Performance															
Mov ID	Turn	Mov Class	Demand Flows [Total HV]		Arrival Flows [Total HV]		Deg. Satn	Aver. Delay	Level of Service	95% Back Of Queue [Veh. Dist]		Prop. Que	Eff. Stop Rate	Aver. No. of Cycles	Aver. Speed
			veh/h	%	veh/h	%	v/c	sec		veh	m				km/h
South: Forest Way (S)															
1	L2	All MCs	42	2.5	42	2.5	0.928	42.7	LOS D	70.3	519.9	0.98	0.98	1.08	39.4
2	T1	All MCs	2064	6.7	2064	6.7	*0.928	44.0	LOS D	70.3	519.9	0.98	0.98	1.09	41.0
3	R2	All MCs	82	2.6	82	2.6	0.585	86.6	LOS F	5.3	37.9	1.00	0.79	1.02	28.6
Approach			2188	6.4	2188	6.4	0.928	45.6	LOS D	70.3	519.9	0.98	0.97	1.08	40.3
East: Morgan Road (E)															
4	L2	All MCs	192	0.0	192	0.0	0.103	9.3	LOS A	0.0	0.0	0.00	0.57	0.00	59.4
5	T1	All MCs	14	0.0	14	0.0	0.043	49.3	LOS D	0.7	5.1	0.87	0.61	0.87	36.2
6	R2	All MCs	178	0.0	178	0.0	*0.741	66.4	LOS E	11.4	80.0	1.00	0.87	1.09	30.1
Approach			383	0.0	383	0.0	0.741	37.3	LOS C	11.4	80.0	0.50	0.71	0.54	40.3
North: Forest Way (N)															
7	L2	All MCs	78	0.0	78	0.0	0.787	25.5	LOS B	41.7	311.8	0.80	0.75	0.80	48.5
8	T1	All MCs	1666	8.7	1666	8.7	0.787	23.9	LOS B	41.7	311.8	0.80	0.74	0.80	51.1
9	R2	All MCs	120	7.0	120	7.0	*0.882	91.9	LOS F	8.6	63.8	1.00	0.96	1.36	26.1
Approach			1864	8.2	1864	8.2	0.882	28.4	LOS B	41.7	311.8	0.82	0.76	0.84	48.0
West: Wyatt Avenue (W)															
10	L2	All MCs	187	2.8	187	2.8	0.562	67.6	LOS E	11.0	78.8	0.92	0.81	0.92	34.1
11	T1	All MCs	13	0.0	13	0.0	0.562	77.6	LOS F	11.0	78.8	0.92	0.81	0.92	35.5
12	R2	All MCs	117	0.9	117	0.9	0.535	79.2	LOS F	7.0	49.3	0.97	0.80	0.97	31.2
Approach			317	2.0	317	2.0	0.562	72.3	LOS F	11.0	78.8	0.94	0.81	0.94	33.0
All Vehicles			4753	6.3	4753	6.3	0.928	39.9	LOS C	70.3	519.9	0.87	0.86	0.93	42.4

Site Level of Service (LOS) Method: Delay (RTA NSW). Site LOS Method is specified in the Parameter Settings dialog (Options tab).

Vehicle movement LOS values are based on average delay per movement.

Intersection and Approach LOS values are based on average delay for all vehicle movements.

Delay Model: SIDRA Standard (Control Delay: Geometric Delay is included).

Queue Model: SIDRA queue estimation methods are used for Back of Queue and Queue at Start of Green.

Gap-Acceptance Capacity Formula: SIDRA Standard (Akçelik M3D).

HV (%) values are calculated for All Movement Classes of All Heavy Vehicle Model Designation.

Arrival Flows used in performance calculations are adjusted to include any Initial Queued Demand and Upstream Capacity Constraint effects.

* Critical Movement (Signal Timing)

Pedestrian Movement Performance											
Mov ID	Input Crossing	Dem. Flow	Aver. Delay	Level of Service	AVERAGE BACK OF QUEUE [Ped Dist]		Prop. Que	Eff. Stop Rate	Travel Time	Travel Dist.	Aver. Speed
	ped/h	ped/h	sec		ped	m			sec	m	m/sec
South: Forest Way (S)											
P1	Full	6	59.2	LOS E	0.0	0.0	0.95	0.95	225.8	200.0	0.89

East: Morgan Road (E)												
P2	Full	3	3	59.1	LOS E	0.0	0.0	0.95	0.95	225.8	200.0	0.89
North: Forest Way (N)												
P3	Full	6	6	59.2	LOS E	0.0	0.0	0.95	0.95	225.8	200.0	0.89
West: Wyatt Avenue (W)												
P4	Full	3	3	59.1	LOS E	0.0	0.0	0.95	0.95	225.8	200.0	0.89
All	Pedestrians	18	19	59.2	LOS E	0.0	0.0	0.95	0.95	225.8	200.0	0.89

Level of Service (LOS) Method: SIDRA Pedestrian LOS Method (Based on Average Delay)

Pedestrian movement LOS values are based on average delay per pedestrian movement.

Intersection LOS value for Pedestrians is based on average delay for all pedestrian movements.

SIDRA INTERSECTION 9.1 | Copyright © 2000-2022 Akcelik and Associates Pty Ltd | sidrasolutions.com
 Organisation: JMT CONSULTING | Licence: NETWORK / 1PC | Processed: Monday, 4 September 2023 8:02:22 PM
 Project: C:\JMT Consulting\Projects\2046 - Belrose PP\Internal\Belrose SIDRA_Updated Aug23.sip9

PHASING SUMMARY

Site: 101 [AM FutureBase + Proposal + Slip Lane (Site Folder: Forest Way / Morgan Road - Typical Day)]

Output produced by SIDRA INTERSECTION Version: 9.1.1.200

Forest Way / Morgan Road

Site Category: (None)

Signals - EQUISAT (Fixed-Time/SCATS) Isolated Cycle Time = 130 seconds (Site User-Given Cycle Time)

Variable Sequence Analysis applied. The results are given for the selected output sequence.

Timings based on settings in the Site Phasing & Timing dialog

Phase Times determined by the program

Phase Sequence: Leading Right Turn

Input Phase Sequence: A, B, B1*, B2*, C

Output Phase Sequence: A, B, C

Reference Phase: Phase B

(* Variable Phase)

Phase Timing Summary

Phase	A	B	C
Phase Change Time (sec)	114	0	87
Green Time (sec)	10	81	21
Phase Time (sec)	16	87	27
Phase Split	12%	67%	21%
Phase Frequency (%)	100.0 ⁴	100.0 ⁴	100.0 ⁴

See the Timing Analysis report for more detailed information including input values of Yellow Time and All-Red Time, and information on any adjustments to Intergreen Time, Phase Time and Green Time values in cases of Pedestrian Actuation, Minor Phase Actuation and Phase Frequency values (user-specified or implied) less than 100%.

⁴ Phase Frequency specified by the user (phase times not specified).

Output Phase Sequence

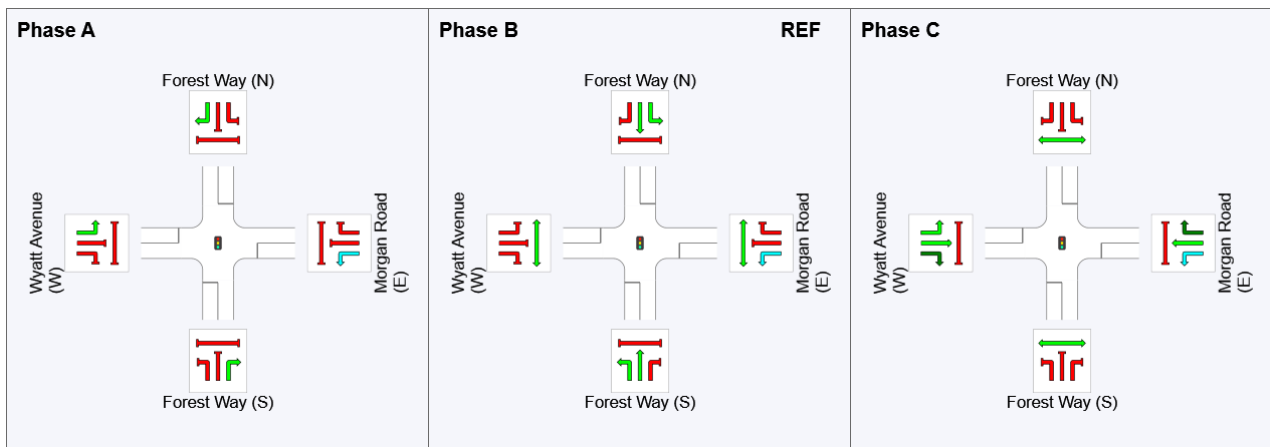

REF: Reference Phase

VAR: Variable Phase

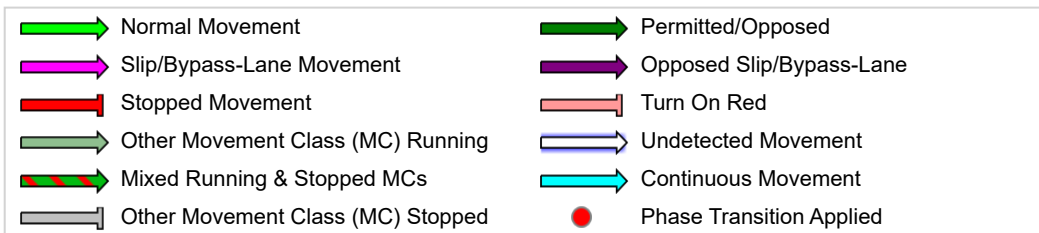

SITE LAYOUT

 Site: 101 [PM Existing (Site Folder: Forest Way / Morgan Road - Typical Day)]

Forest Way / Morgan Road

Site Category: (None)

Signals - EQUISAT (Fixed-Time/SCATS) Isolated

Layout pictures are schematic functional drawings reflecting input data. They are not design drawings.

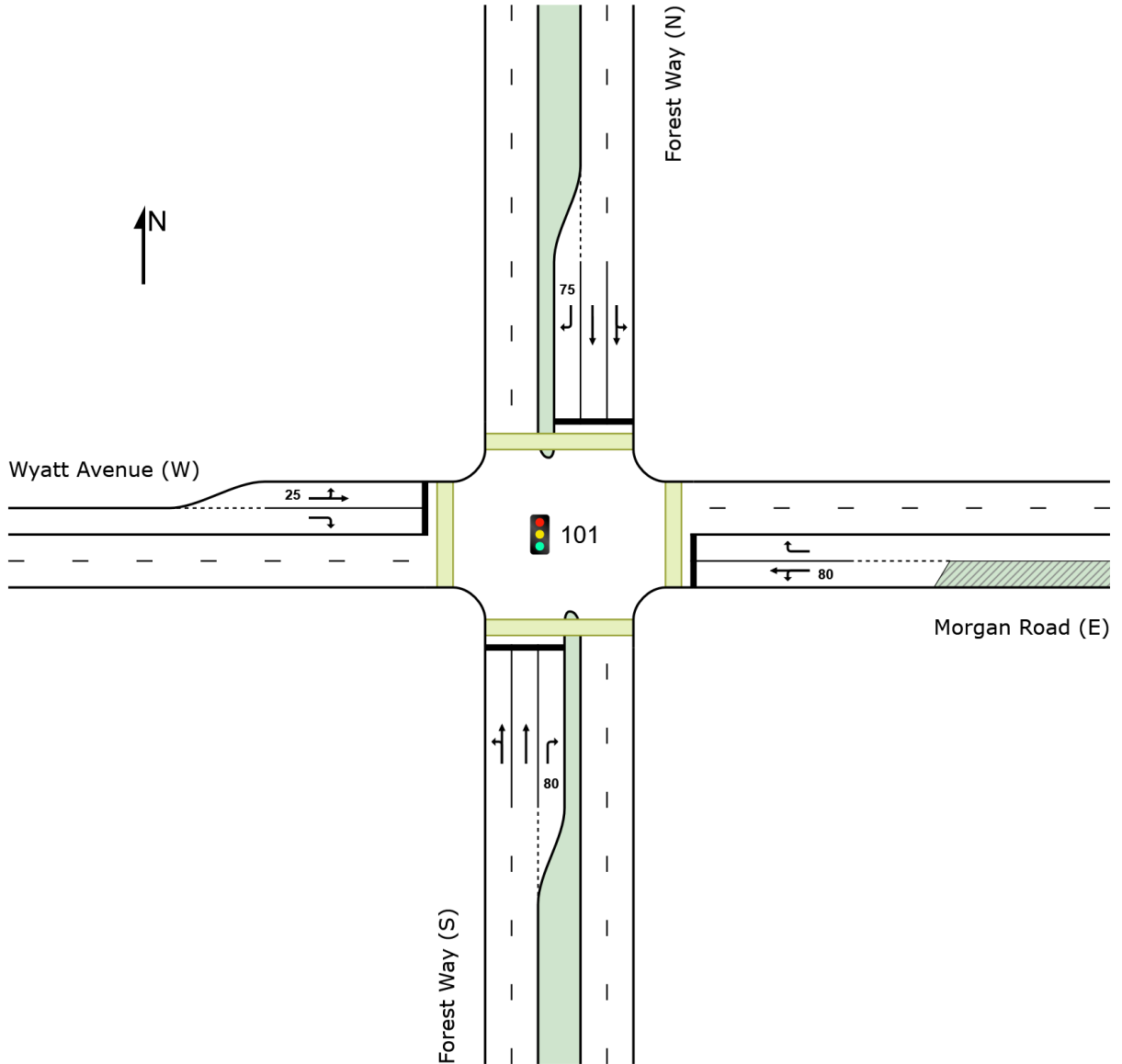

MOVEMENT SUMMARY

Site: 101 [PM Existing (Site Folder: Forest Way / Morgan Road - Typical Day)]

Output produced by SIDRA INTERSECTION Version: 9.1.1.200

Forest Way / Morgan Road

Site Category: (None)

Signals - EQUISAT (Fixed-Time/SCATS) Isolated Cycle Time = 130 seconds (Site User-Given Cycle Time)

Variable Sequence Analysis applied. The results are given for the selected output sequence.

Vehicle Movement Performance															
Mov ID	Turn	Mov Class	Demand Flows		Arrival Flows		Deg. Satn	Aver. Delay	Level of Service	95% Back Of Queue		Prop. Que	Eff. Stop Rate	Aver. No. of Cycles	Aver. Speed
			[Total HV]	[Total HV]	[Total HV]	[Total HV]				[Veh.]	[Dist]				
			veh/h	%	veh/h	%	v/c	sec		veh	m				km/h
South: Forest Way (S)															
1	L2	All MCs	19	0.0	19	0.0	0.627	20.9	LOS B	28.2	205.7	0.64	0.59	0.64	52.4
2	T1	All MCs	1522	5.0	1522	5.0	0.627	16.1	LOS B	28.2	205.7	0.64	0.59	0.64	55.2
3	R2	All MCs	21	5.0	21	5.0	0.254	79.4	LOS F	1.4	10.0	1.00	0.70	1.00	27.7
Approach			1562	4.9	1562	4.9	0.627	17.0	LOS B	28.2	205.7	0.64	0.59	0.64	54.4
East: Morgan Road (E)															
4	L2	All MCs	46	0.0	46	0.0	0.154	49.7	LOS D	3.0	21.1	0.86	0.73	0.86	34.5
5	T1	All MCs	12	0.0	12	0.0	0.154	53.6	LOS D	3.0	21.1	0.86	0.73	0.86	35.6
6	R2	All MCs	55	1.9	55	1.9	*0.232	59.5	LOS E	3.1	22.1	0.92	0.75	0.92	31.7
Approach			113	0.9	113	0.9	0.232	54.9	LOS D	3.1	22.1	0.89	0.74	0.89	33.2
North: Forest Way (N)															
7	L2	All MCs	45	2.3	45	2.3	*0.752	24.0	LOS B	39.6	285.3	0.74	0.69	0.74	50.2
8	T1	All MCs	1799	3.3	1799	3.3	0.752	20.2	LOS B	39.6	285.3	0.74	0.69	0.74	53.3
9	R2	All MCs	52	14.3	52	14.3	*0.663	86.7	LOS F	3.5	27.7	1.00	0.81	1.13	26.4
Approach			1896	3.6	1896	3.6	0.752	22.1	LOS B	39.6	285.3	0.75	0.69	0.75	51.8
West: Wyatt Avenue (W)															
10	L2	All MCs	44	21.4	44	21.4	0.127	47.9	LOS D	2.4	19.4	0.82	0.73	0.82	33.3
11	T1	All MCs	3	0.0	3	0.0	0.127	51.0	LOS D	2.4	19.4	0.82	0.73	0.82	36.6
12	R2	All MCs	37	8.6	37	8.6	0.165	59.0	LOS E	2.1	15.5	0.90	0.74	0.90	31.3
Approach			84	15.0	84	15.0	0.165	52.9	LOS D	2.4	19.4	0.86	0.73	0.86	32.5
All Vehicles			3655	4.3	3655	4.3	0.752	21.6	LOS B	39.6	285.3	0.71	0.65	0.71	51.3

Site Level of Service (LOS) Method: Delay (RTA NSW). Site LOS Method is specified in the Parameter Settings dialog (Options tab).

Vehicle movement LOS values are based on average delay per movement.

Intersection and Approach LOS values are based on average delay for all vehicle movements.

Delay Model: SIDRA Standard (Control Delay: Geometric Delay is included).

Queue Model: SIDRA queue estimation methods are used for Back of Queue and Queue at Start of Green.

Gap-Acceptance Capacity Formula: SIDRA Standard (Akçelik M3D).

HV (%) values are calculated for All Movement Classes of All Heavy Vehicle Model Designation.

Arrival Flows used in performance calculations are adjusted to include any Initial Queued Demand and Upstream Capacity Constraint effects.

* Critical Movement (Signal Timing)

Pedestrian Movement Performance												
Mov ID	Crossing	Input Vol.	Dem. Flow	Aver. Delay	Level of Service	AVERAGE BACK OF QUEUE		Prop. Que	Eff. Stop Rate	Travel Time	Travel Dist.	Aver. Speed
						[Ped]	[Dist]					
		ped/h	ped/h	sec		ped	m			sec	m	m/sec
South: Forest Way (S)												
P1	Full	11	12	59.2	LOS E	0.0	0.0	0.95	0.95	225.8	200.0	0.89

East: Morgan Road (E)												
P2	Full	22	23	59.2	LOS E	0.1	0.1	0.95	0.95	225.9	200.0	0.89
North: Forest Way (N)												
P3	Full	9	9	59.2	LOS E	0.0	0.0	0.95	0.95	225.8	200.0	0.89
West: Wyatt Avenue (W)												
P4	Full	17	18	59.2	LOS E	0.1	0.1	0.95	0.95	225.8	200.0	0.89
All	Pedestrians	59	62	59.2	LOS E	0.1	0.1	0.95	0.95	225.8	200.0	0.89

Level of Service (LOS) Method: SIDRA Pedestrian LOS Method (Based on Average Delay)

Pedestrian movement LOS values are based on average delay per pedestrian movement.

Intersection LOS value for Pedestrians is based on average delay for all pedestrian movements.

SIDRA INTERSECTION 9.1 | Copyright © 2000-2022 Akcelik and Associates Pty Ltd | sidrasolutions.com

Organisation: JMT CONSULTING | Licence: NETWORK / 1PC | Processed: Wednesday, 13 September 2023 3:11:26 PM

Project: C:\JMT Consulting\Projects\2046 - Belrose PP\Internal\Belrose SIDRA_Updated Aug23.sip9

PHASING SUMMARY

Site: 101 [PM Existing (Site Folder: Forest Way / Morgan Road - Typical Day)]

Output produced by SIDRA INTERSECTION Version: 9.1.1.200

Forest Way / Morgan Road

Site Category: (None)

Signals - EQUISAT (Fixed-Time/SCATS) Isolated Cycle Time = 130 seconds (Site User-Given Cycle Time)

Variable Sequence Analysis applied. The results are given for the selected output sequence.

Timings based on settings in the Site Phasing & Timing dialog

Phase Times determined by the program

Phase Sequence: Leading Right Turn

Input Phase Sequence: A*, B, B1*, C

Output Phase Sequence: A*, B, C

Reference Phase: Phase B

(* Variable Phase)

Phase Timing Summary

Phase	A	B	C
Phase Change Time (sec)	118	0	91
Green Time (sec)	6	85	21
Phase Time (sec)	12	91	27
Phase Split	9%	70%	21%
Phase Frequency (%)	100.0 ⁴	100.0 ⁴	100.0 ⁴

See the Timing Analysis report for more detailed information including input values of Yellow Time and All-Red Time, and information on any adjustments to Intergreen Time, Phase Time and Green Time values in cases of Pedestrian Actuation, Minor Phase Actuation and Phase Frequency values (user-specified or implied) less than 100%.

⁴ Phase Frequency specified by the user (phase times not specified).

Output Phase Sequence

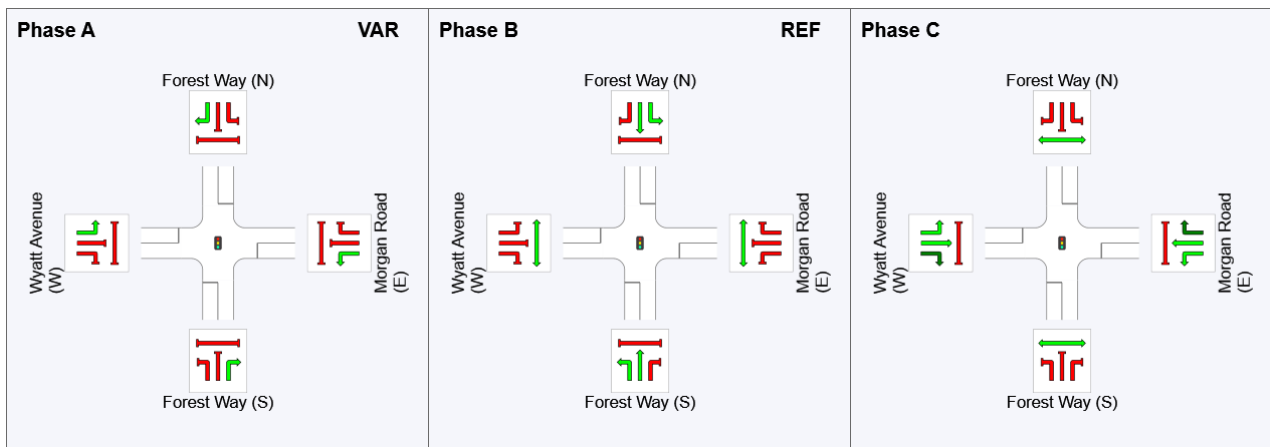

REF: Reference Phase

VAR: Variable Phase

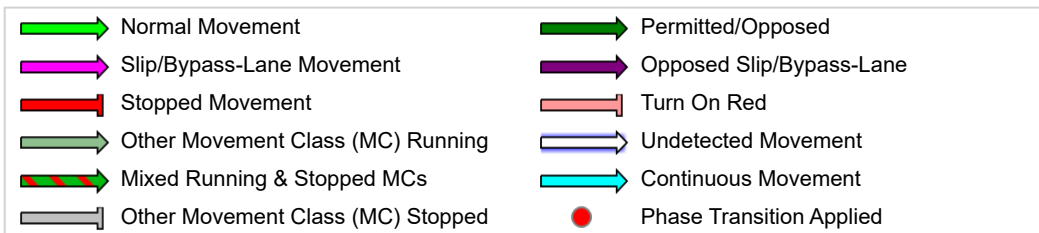

SITE LAYOUT

 Site: 101 [PM FutureBase (Site Folder: Forest Way / Morgan Road - Typical Day)]

Forest Way / Morgan Road

Site Category: (None)

Signals - EQUISAT (Fixed-Time/SCATS) Isolated

Layout pictures are schematic functional drawings reflecting input data. They are not design drawings.

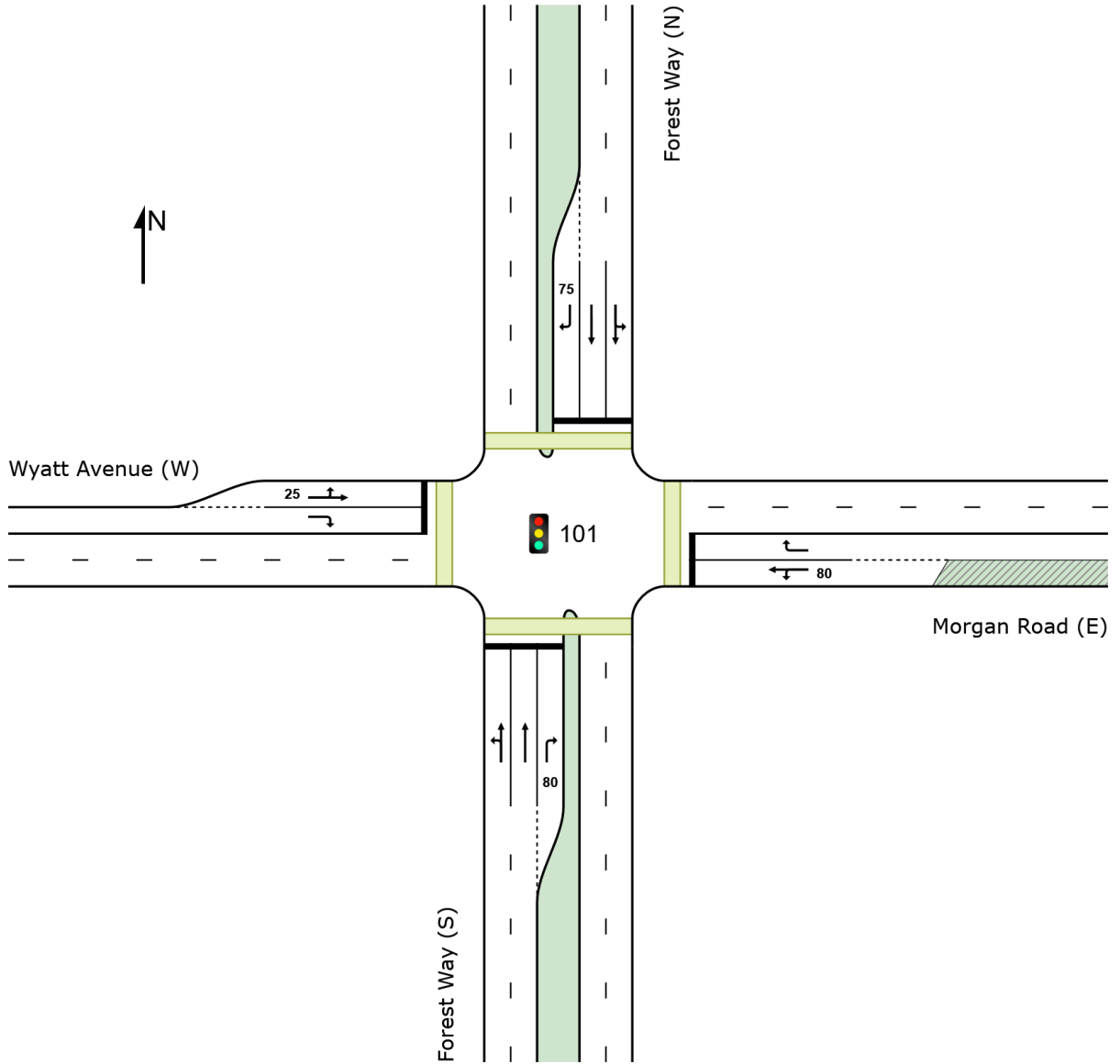

MOVEMENT SUMMARY

Site: 101 [PM FutureBase (Site Folder: Forest Way / Morgan Road - Typical Day)]

Output produced by SIDRA INTERSECTION Version: 9.1.1.200

Forest Way / Morgan Road

Site Category: (None)

Signals - EQUISAT (Fixed-Time/SCATS) Isolated Cycle Time = 130 seconds (Site User-Given Cycle Time)

Variable Sequence Analysis applied. The results are given for the selected output sequence.

Vehicle Movement Performance															
Mov ID	Turn	Mov Class	Demand Flows		Arrival Flows		Deg. Satn	Aver. Delay	Level of Service	95% Back Of Queue		Prop. Que	Eff. Stop Rate	Aver. No. of Cycles	Aver. Speed
			[Total HV]	[Total HV]	[Total HV]	[Total HV]				[Veh.]	[Dist]				
			veh/h	%	veh/h	%	v/c	sec			veh	m			km/h
South: Forest Way (S)															
1	L2	All MCs	21	0.0	21	0.0	0.691	22.0	LOS B	33.5	244.1	0.69	0.64	0.69	51.6
2	T1	All MCs	1675	5.0	1675	5.0	0.691	18.0	LOS B	33.5	244.1	0.69	0.63	0.69	54.3
3	R2	All MCs	23	4.5	23	4.5	0.279	81.4	LOS F	1.5	11.0	1.00	0.71	1.00	27.7
Approach			1719	4.9	1719	4.9	0.691	18.9	LOS B	33.5	244.1	0.69	0.63	0.69	53.6
East: Morgan Road (E)															
4	L2	All MCs	51	0.0	51	0.0	0.168	49.9	LOS D	3.3	23.1	0.86	0.74	0.86	34.4
5	T1	All MCs	13	0.0	13	0.0	0.168	53.8	LOS D	3.3	23.1	0.86	0.74	0.86	35.6
6	R2	All MCs	60	1.8	60	1.8	*0.254	59.8	LOS E	3.4	24.3	0.92	0.76	0.92	31.7
Approach			123	0.9	123	0.9	0.254	55.1	LOS D	3.4	24.3	0.89	0.75	0.89	33.1
North: Forest Way (N)															
7	L2	All MCs	57	1.9	57	1.9	*0.832	26.0	LOS B	48.9	352.1	0.83	0.77	0.83	49.0
8	T1	All MCs	1979	3.4	1979	3.4	0.832	23.2	LOS B	48.9	352.1	0.83	0.76	0.83	51.9
9	R2	All MCs	56	13.2	56	13.2	*0.712	89.8	LOS F	3.8	30.0	1.00	0.83	1.18	26.3
Approach			2092	3.6	2092	3.6	0.832	25.1	LOS B	48.9	352.1	0.83	0.76	0.84	50.5
West: Wyatt Avenue (W)															
10	L2	All MCs	48	21.7	48	21.7	0.138	48.1	LOS D	2.6	21.2	0.82	0.74	0.82	33.2
11	T1	All MCs	3	0.0	3	0.0	0.138	51.2	LOS D	2.6	21.2	0.82	0.74	0.82	36.5
12	R2	All MCs	41	7.7	41	7.7	0.184	59.2	LOS E	2.3	17.3	0.91	0.74	0.91	31.4
Approach			93	14.8	93	14.8	0.184	53.1	LOS D	2.6	21.2	0.86	0.74	0.86	32.4
All Vehicles			4026	4.3	4026	4.3	0.832	24.0	LOS B	48.9	352.1	0.77	0.71	0.78	50.3

Site Level of Service (LOS) Method: Delay (RTA NSW). Site LOS Method is specified in the Parameter Settings dialog (Options tab).

Vehicle movement LOS values are based on average delay per movement.

Intersection and Approach LOS values are based on average delay for all vehicle movements.

Delay Model: SIDRA Standard (Control Delay: Geometric Delay is included).

Queue Model: SIDRA queue estimation methods are used for Back of Queue and Queue at Start of Green.

Gap-Acceptance Capacity Formula: SIDRA Standard (Akçelik M3D).

HV (%) values are calculated for All Movement Classes of All Heavy Vehicle Model Designation.

Arrival Flows used in performance calculations are adjusted to include any Initial Queued Demand and Upstream Capacity Constraint effects.

* Critical Movement (Signal Timing)

Pedestrian Movement Performance												
Mov ID	Crossing	Input Vol.	Dem. Flow	Aver. Delay	Level of Service	AVERAGE BACK OF QUEUE		Prop. Que	Eff. Stop Rate	Travel Time	Travel Dist.	Aver. Speed
						[Ped]	[Dist]					
		ped/h	ped/h	sec		ped	m			sec	m	m/sec
South: Forest Way (S)												
P1	Full	11	12	59.2	LOS E	0.0	0.0	0.95	0.95	225.8	200.0	0.89

East: Morgan Road (E)												
P2	Full	22	23	59.2	LOS E	0.1	0.1	0.95	0.95	225.9	200.0	0.89
North: Forest Way (N)												
P3	Full	9	9	59.2	LOS E	0.0	0.0	0.95	0.95	225.8	200.0	0.89
West: Wyatt Avenue (W)												
P4	Full	17	18	59.2	LOS E	0.1	0.1	0.95	0.95	225.8	200.0	0.89
All	Pedestrians	59	62	59.2	LOS E	0.1	0.1	0.95	0.95	225.8	200.0	0.89

Level of Service (LOS) Method: SIDRA Pedestrian LOS Method (Based on Average Delay)

Pedestrian movement LOS values are based on average delay per pedestrian movement.

Intersection LOS value for Pedestrians is based on average delay for all pedestrian movements.

SIDRA INTERSECTION 9.1 | Copyright © 2000-2022 Akcelik and Associates Pty Ltd | sidrasolutions.com

Organisation: JMT CONSULTING | Licence: NETWORK / 1PC | Processed: Wednesday, 13 September 2023 3:11:27 PM

Project: C:\JMT Consulting\Projects\2046 - Belrose PP\Internal\Belrose SIDRA_Updated Aug23.sip9

PHASING SUMMARY

Site: 101 [PM FutureBase (Site Folder: Forest Way / Morgan Road - Typical Day)]

Output produced by SIDRA INTERSECTION Version: 9.1.1.200

Forest Way / Morgan Road

Site Category: (None)

Signals - EQUISAT (Fixed-Time/SCATS) Isolated Cycle Time = 130 seconds (Site User-Given Cycle Time)

Variable Sequence Analysis applied. The results are given for the selected output sequence.

Timings based on settings in the Site Phasing & Timing dialog

Phase Times determined by the program

Phase Sequence: Leading Right Turn

Input Phase Sequence: A*, B, B1*, C

Output Phase Sequence: A*, B, C

Reference Phase: Phase B

(* Variable Phase)

Phase Timing Summary

Phase	A	B	C
Phase Change Time (sec)	118	0	91
Green Time (sec)	6	85	21
Phase Time (sec)	12	91	27
Phase Split	9%	70%	21%
Phase Frequency (%)	100.0 ⁴	100.0 ⁴	100.0 ⁴

See the Timing Analysis report for more detailed information including input values of Yellow Time and All-Red Time, and information on any adjustments to Intergreen Time, Phase Time and Green Time values in cases of Pedestrian Actuation, Minor Phase Actuation and Phase Frequency values (user-specified or implied) less than 100%.

⁴ Phase Frequency specified by the user (phase times not specified).

Output Phase Sequence

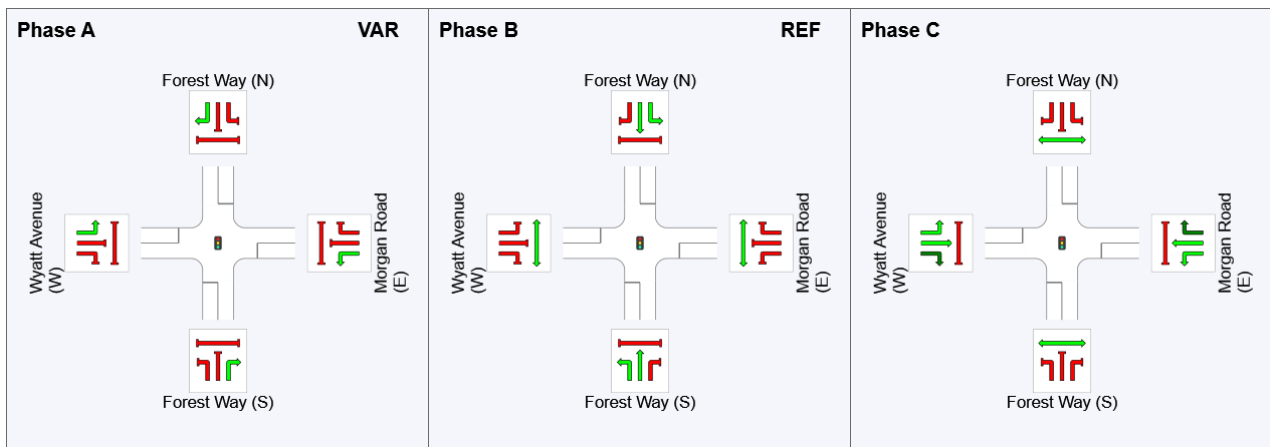

REF: Reference Phase

VAR: Variable Phase



SITE LAYOUT

Site: 101 [PM FutureBase + Proposal + Slip Lane (Site Folder: Forest Way / Morgan Road - Typical Day)]

Forest Way / Morgan Road

Site Category: (None)

Signals - EQUISAT (Fixed-Time/SCATS) Isolated

Layout pictures are schematic functional drawings reflecting input data. They are not design drawings.

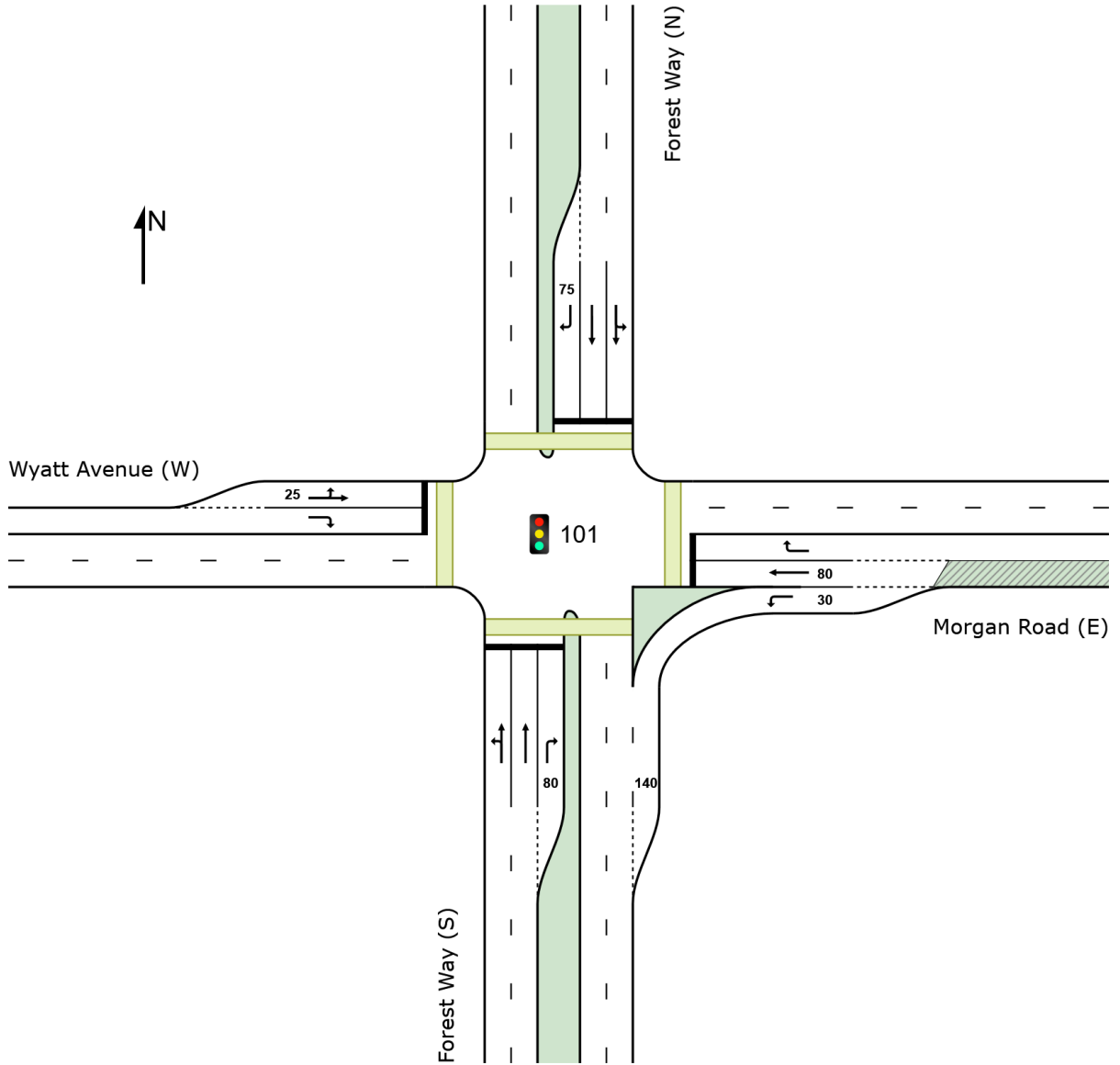

MOVEMENT SUMMARY

Site: 101 [PM FutureBase + Proposal + Slip Lane (Site Folder: Forest Way / Morgan Road - Typical Day)]

Output produced by SIDRA INTERSECTION Version: 9.1.1.200

Forest Way / Morgan Road

Site Category: (None)

Signals - EQUISAT (Fixed-Time/SCATS) Isolated Cycle Time = 130 seconds (Site User-Given Cycle Time)

Variable Sequence Analysis applied. The results are given for the selected output sequence.

Vehicle Movement Performance															
Mov ID	Turn	Mov Class	Demand Flows [Total HV]		Arrival Flows [Total HV]		Deg. Satn	Aver. Delay	Level of Service	95% Back Of Queue [Veh. Dist]		Prop. Que	Eff. Stop Rate	Aver. No. of Cycles	Aver. Speed
			veh/h	%	veh/h	%	v/c	sec		veh	m				km/h
South: Forest Way (S)															
1	L2	All MCs	21	0.0	21	0.0	0.783	27.9	LOS B	41.8	304.4	0.82	0.76	0.82	47.8
2	T1	All MCs	1675	5.0	1675	5.0	0.783	25.1	LOS B	41.8	304.4	0.82	0.76	0.82	50.1
3	R2	All MCs	175	0.6	175	0.6	*0.945	99.7	LOS F	13.4	94.5	1.00	1.04	1.46	25.1
Approach			1871	4.5	1871	4.5	0.945	32.1	LOS C	41.8	304.4	0.84	0.78	0.88	45.8
East: Morgan Road (E)															
4	L2	All MCs	88	0.0	88	0.0	0.048	9.6	LOS A	0.0	0.0	0.00	0.57	0.00	59.5
5	T1	All MCs	13	0.0	13	0.0	0.040	49.3	LOS D	0.7	4.7	0.87	0.61	0.87	36.2
6	R2	All MCs	77	1.4	77	1.4	*0.324	60.5	LOS E	4.4	31.5	0.93	0.77	0.93	31.5
Approach			178	0.6	178	0.6	0.324	34.4	LOS C	4.4	31.5	0.46	0.66	0.46	41.7
North: Forest Way (N)															
7	L2	All MCs	124	0.8	124	0.8	0.940	49.9	LOS D	73.5	527.7	1.00	1.02	1.13	37.2
8	T1	All MCs	1979	3.4	1979	3.4	*0.940	50.7	LOS D	73.5	527.7	1.00	1.03	1.14	38.6
9	R2	All MCs	56	13.2	56	13.2	0.329	83.5	LOS F	3.4	26.6	0.97	0.76	0.97	28.9
Approach			2159	3.5	2159	3.5	0.940	51.5	LOS D	73.5	527.7	1.00	1.02	1.13	38.2
West: Wyatt Avenue (W)															
10	L2	All MCs	48	21.7	48	21.7	0.121	43.4	LOS D	2.4	20.1	0.78	0.73	0.78	34.5
11	T1	All MCs	3	0.0	3	0.0	0.121	52.7	LOS D	2.4	20.1	0.78	0.73	0.78	38.2
12	R2	All MCs	41	7.7	41	7.7	0.184	59.2	LOS E	2.3	17.3	0.91	0.74	0.91	31.4
Approach			93	14.8	93	14.8	0.184	50.7	LOS D	2.4	20.1	0.84	0.74	0.84	33.1
All Vehicles			4300	4.0	4300	4.0	0.945	42.3	LOS C	73.5	527.7	0.90	0.89	0.99	41.2

Site Level of Service (LOS) Method: Delay (RTA NSW). Site LOS Method is specified in the Parameter Settings dialog (Options tab).

Vehicle movement LOS values are based on average delay per movement.

Intersection and Approach LOS values are based on average delay for all vehicle movements.

Delay Model: SIDRA Standard (Control Delay: Geometric Delay is included).

Queue Model: SIDRA queue estimation methods are used for Back of Queue and Queue at Start of Green.

Gap-Acceptance Capacity Formula: SIDRA Standard (Akçelik M3D).

HV (%) values are calculated for All Movement Classes of All Heavy Vehicle Model Designation.

Arrival Flows used in performance calculations are adjusted to include any Initial Queued Demand and Upstream Capacity Constraint effects.

* Critical Movement (Signal Timing)

Pedestrian Movement Performance												
Mov ID	Input Crossing	Dem. Flow	Aver. Delay	Level of Service	AVERAGE BACK OF QUEUE [Ped Dist]		Prop. Que	Eff. Stop Rate	Travel Time	Travel Dist.	Aver. Speed	
	ped/h	ped/h	sec		ped	m			sec	m	m/sec	
South: Forest Way (S)												
P1	Full	11	12	59.2	LOS E	0.0	0.0	0.95	0.95	225.8	200.0	0.89

East: Morgan Road (E)												
P2	Full	22	23	59.2	LOS E	0.1	0.1	0.95	0.95	225.9	200.0	0.89
North: Forest Way (N)												
P3	Full	9	9	59.2	LOS E	0.0	0.0	0.95	0.95	225.8	200.0	0.89
West: Wyatt Avenue (W)												
P4	Full	17	18	59.2	LOS E	0.1	0.1	0.95	0.95	225.8	200.0	0.89
All	Pedestrians	59	62	59.2	LOS E	0.1	0.1	0.95	0.95	225.8	200.0	0.89

Level of Service (LOS) Method: SIDRA Pedestrian LOS Method (Based on Average Delay)

Pedestrian movement LOS values are based on average delay per pedestrian movement.

Intersection LOS value for Pedestrians is based on average delay for all pedestrian movements.

SIDRA INTERSECTION 9.1 | Copyright © 2000-2022 Akcelik and Associates Pty Ltd | sidrasolutions.com

Organisation: JMT CONSULTING | Licence: NETWORK / 1PC | Processed: Wednesday, 13 September 2023 3:11:27 PM

Project: C:\JMT Consulting\Projects\2046 - Belrose PP\Internal\Belrose SIDRA_Updated Aug23.sip9

PHASING SUMMARY

Site: 101 [PM FutureBase + Proposal + Slip Lane (Site Folder: Forest Way / Morgan Road - Typical Day)]

Output produced by SIDRA INTERSECTION Version: 9.1.1.200

Forest Way / Morgan Road

Site Category: (None)

Signals - EQUISAT (Fixed-Time/SCATS) Isolated Cycle Time = 130 seconds (Site User-Given Cycle Time)

Variable Sequence Analysis applied. The results are given for the selected output sequence.

Timings based on settings in the Site Phasing & Timing dialog

Phase Times determined by the program

Phase Sequence: Leading Right Turn

Input Phase Sequence: A*, B, B1*, B2*, C

Output Phase Sequence: A*, B, C

Reference Phase: Phase B

(* Variable Phase)

Phase Timing Summary

Phase	A	B	C
Phase Change Time (sec)	111	0	84
Green Time (sec)	13	78	21
Phase Time (sec)	19	84	27
Phase Split	15%	65%	21%
Phase Frequency (%)	100.0 ⁴	100.0 ⁴	100.0 ⁴

See the Timing Analysis report for more detailed information including input values of Yellow Time and All-Red Time, and information on any adjustments to Intergreen Time, Phase Time and Green Time values in cases of Pedestrian Actuation, Minor Phase Actuation and Phase Frequency values (user-specified or implied) less than 100%.

⁴ Phase Frequency specified by the user (phase times not specified).

Output Phase Sequence

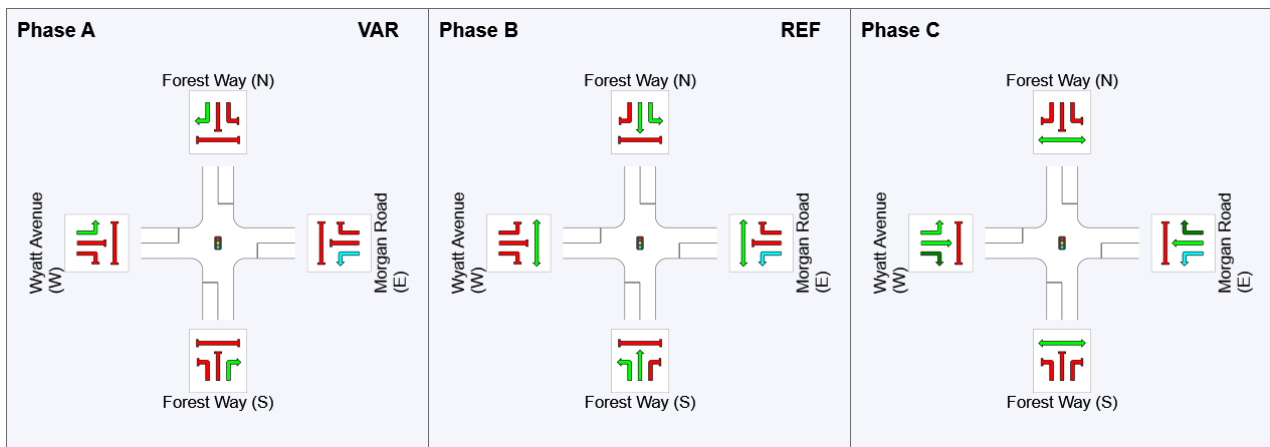

REF: Reference Phase

VAR: Variable Phase

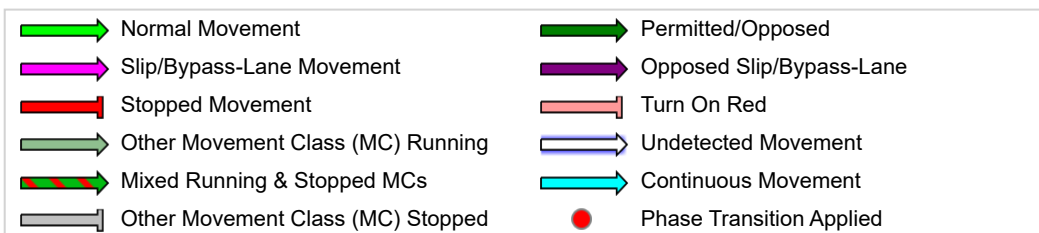

SITE LAYOUT

 Site: 101 [PM FutureBase + PP (Bushfire) - Full Yield (Site Folder: Forest Way / Morgan Road - Bushfire Evacuation)]

Forest Way / Morgan Road

Site Category: (None)

Signals - EQUISAT (Fixed-Time/SCATS) Isolated

Layout pictures are schematic functional drawings reflecting input data. They are not design drawings.

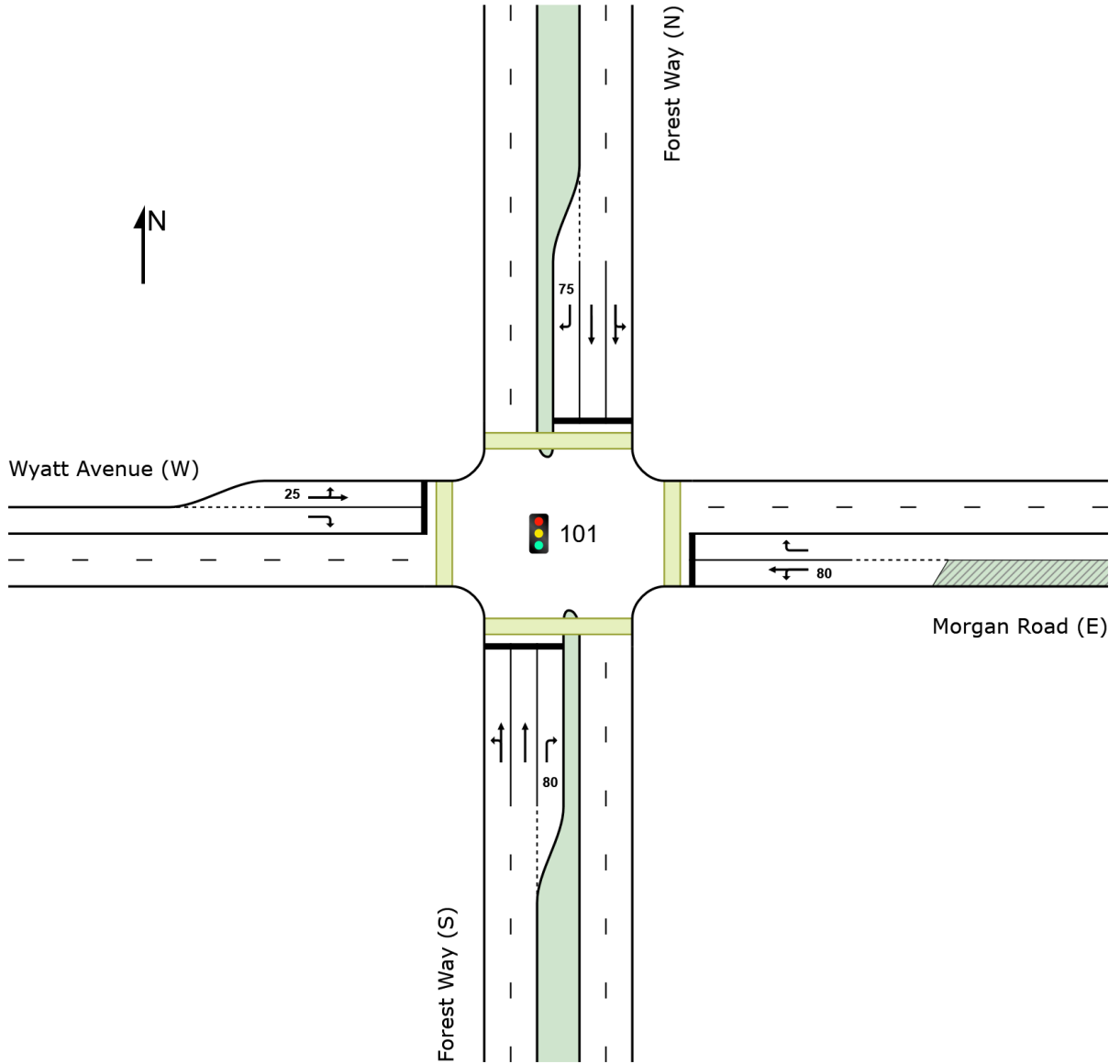

MOVEMENT SUMMARY

Site: 101 [PM FutureBase + PP (Bushfire) - Full Yield (Site Folder: Forest Way / Morgan Road - Bushfire Evacuation)]

Output produced by SIDRA INTERSECTION Version: 9.1.1.200

Forest Way / Morgan Road

Site Category: (None)

Signals - EQUISAT (Fixed-Time/SCATS) Isolated Cycle Time = 130 seconds (Site User-Given Cycle Time)

Variable Sequence Analysis applied. The results are given for the selected output sequence.

Vehicle Movement Performance															
Mov ID	Turn	Mov Class	Demand Flows		Arrival Flows		Deg. Satn	Aver. Delay	Level of Service	95% Back Of Queue		Prop. Que	Eff. Stop Rate	Aver. No. of Cycles	Aver. Speed
			[Total HV]	[Total HV]	[Total HV]	[Total HV]				[Veh.]	[Dist]				
			veh/h	%	veh/h	%	v/c	sec		veh	m				km/h
South: Forest Way (S)															
1	L2	All MCs	21	0.0	21	0.0	0.790	30.4	LOS C	41.4	302.1	0.85	0.78	0.85	46.3
2	T1	All MCs	1675	5.0	1675	5.0	0.790	29.2	LOS C	41.4	302.1	0.85	0.78	0.85	48.4
3	R2	All MCs	250.0		250.0		0.033	86.4	LOS F	0.1	1.3	0.98	0.62	0.98	25.3
Approach			1698	5.0	1698	5.0	0.790	29.3	LOS C	41.4	302.1	0.85	0.78	0.85	48.3
East: Morgan Road (E)															
4	L2	All MCs	568	0.0	568	0.0	*0.931	87.8	LOS F	42.2	295.6	1.00	1.01	1.23	29.1
5	T1	All MCs	1	0.0	1	0.0	0.931	93.4	LOS F	42.2	295.6	1.00	1.01	1.23	29.9
6	R2	All MCs	250.0		250.0		0.007	65.0	LOS E	0.1	1.0	0.78	0.63	0.78	31.2
Approach			572	0.2	572	0.2	0.931	87.7	LOS F	42.2	295.6	1.00	1.01	1.23	29.1
North: Forest Way (N)															
7	L2	All MCs	1	0.0	1	0.0	0.931	49.9	LOS D	68.1	490.6	1.00	1.01	1.12	37.6
8	T1	All MCs	1979	3.4	1979	3.4	*0.931	50.3	LOS D	68.1	490.6	1.00	1.02	1.12	38.8
9	R2	All MCs	56	13.2	56	13.2	0.712	96.4	LOS F	3.8	30.0	1.00	0.83	1.18	26.3
Approach			2036	3.6	2036	3.6	0.931	51.6	LOS D	68.1	490.6	1.00	1.01	1.13	38.3
West: Wyatt Avenue (W)															
10	L2	All MCs	48	21.7	48	21.7	0.101	39.0	LOS C	2.3	18.7	0.73	0.72	0.73	36.2
11	T1	All MCs	3	0.0	3	0.0	0.101	41.0	LOS C	2.3	18.7	0.73	0.72	0.73	40.2
12	R2	All MCs	41	7.7	41	7.7	0.119	48.5	LOS D	2.0	15.3	0.82	0.73	0.82	34.5
Approach			93	14.8	93	14.8	0.119	43.3	LOS D	2.3	18.7	0.77	0.73	0.77	35.5
All Vehicles			4398	3.9	4398	3.9	0.931	47.5	LOS D	68.1	490.6	0.94	0.92	1.03	39.8

Site Level of Service (LOS) Method: Delay (RTA NSW). Site LOS Method is specified in the Parameter Settings dialog (Options tab).

Vehicle movement LOS values are based on average delay per movement.

Intersection and Approach LOS values are based on average delay for all vehicle movements.

Delay Model: SIDRA Standard (Control Delay: Geometric Delay is included).

Queue Model: SIDRA queue estimation methods are used for Back of Queue and Queue at Start of Green.

Gap-Acceptance Capacity Formula: SIDRA Standard (Akçelik M3D).

HV (%) values are calculated for All Movement Classes of All Heavy Vehicle Model Designation.

Arrival Flows used in performance calculations are adjusted to include any Initial Queued Demand and Upstream Capacity Constraint effects.

* Critical Movement (Signal Timing)

Pedestrian Movement Performance												
Mov ID	Crossing	Input Vol.	Dem. Flow	Aver. Delay	Level of Service	AVERAGE BACK OF QUEUE		Prop. Que	Eff. Stop Rate	Travel Time	Travel Dist.	Aver. Speed
						[Ped]	[Dist]					
		ped/h	ped/h	sec		ped	m			sec	m	m/sec
South: Forest Way (S)												
P1	Full	11	12	59.2	LOS E	0.0	0.0	0.95	0.95	225.8	200.0	0.89

East: Morgan Road (E)												
P2	Full	22	23	59.2	LOS E	0.1	0.1	0.95	0.95	225.9	200.0	0.89
North: Forest Way (N)												
P3	Full	9	9	59.2	LOS E	0.0	0.0	0.95	0.95	225.8	200.0	0.89
West: Wyatt Avenue (W)												
P4	Full	17	18	59.2	LOS E	0.1	0.1	0.95	0.95	225.8	200.0	0.89
All	Pedestrians	59	62	59.2	LOS E	0.1	0.1	0.95	0.95	225.8	200.0	0.89

Level of Service (LOS) Method: SIDRA Pedestrian LOS Method (Based on Average Delay)

Pedestrian movement LOS values are based on average delay per pedestrian movement.

Intersection LOS value for Pedestrians is based on average delay for all pedestrian movements.

SIDRA INTERSECTION 9.1 | Copyright © 2000-2022 Akcelik and Associates Pty Ltd | sidrasolutions.com

Organisation: JMT CONSULTING | Licence: NETWORK / 1PC | Processed: Wednesday, 13 September 2023 3:14:01 PM

Project: C:\JMT Consulting\Projects\2046 - Belrose PP\Internal\Belrose SIDRA_Updated Aug23.sip9

PHASING SUMMARY

Site: 101 [PM FutureBase + PP (Bushfire) - Full Yield (Site Folder: Forest Way / Morgan Road - Bushfire Evacuation)]

Output produced by SIDRA INTERSECTION Version: 9.1.1.200

Forest Way / Morgan Road

Site Category: (None)

Signals - EQUISAT (Fixed-Time/SCATS) Isolated Cycle Time = 130 seconds (Site User-Given Cycle Time)

Variable Sequence Analysis applied. The results are given for the selected output sequence.

Timings based on settings in the Site Phasing & Timing dialog

Phase Times determined by the program

Phase Sequence: Leading Right Turn

Input Phase Sequence: A*, B, B1*, B2*, C

Output Phase Sequence: A*, B, C

Reference Phase: Phase B

(* Variable Phase)

Phase Timing Summary

Phase	A	B	C
Phase Change Time (sec)	118	0	80
Green Time (sec)	6	74	32
Phase Time (sec)	12	80	38
Phase Split	9%	62%	29%
Phase Frequency (%)	100.0 ⁴	100.0 ⁴	100.0 ⁴

See the Timing Analysis report for more detailed information including input values of Yellow Time and All-Red Time, and information on any adjustments to Intergreen Time, Phase Time and Green Time values in cases of Pedestrian Actuation, Minor Phase Actuation and Phase Frequency values (user-specified or implied) less than 100%.

⁴ Phase Frequency specified by the user (phase times not specified).

Output Phase Sequence

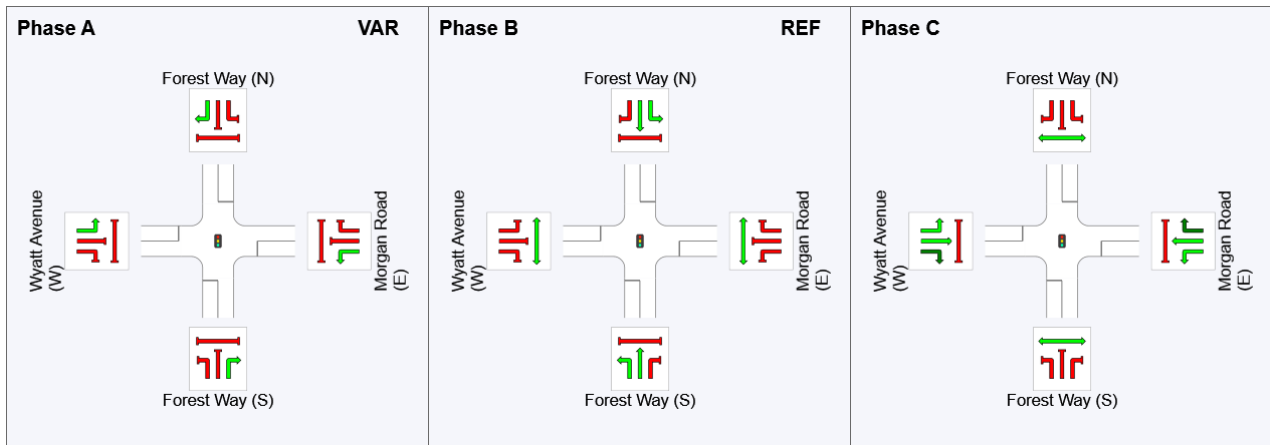

REF: Reference Phase

VAR: Variable Phase



SITE LAYOUT

Site: 101 [PM FutureBase + PP + Slip Lane (Bushfire) - Full Yield (Site Folder: Forest Way / Morgan Road - Bushfire Evacuation)]

Forest Way / Morgan Road
Site Category: (None)
Signals - EQUISAT (Fixed-Time/SCATS) Isolated

Layout pictures are schematic functional drawings reflecting input data. They are not design drawings.

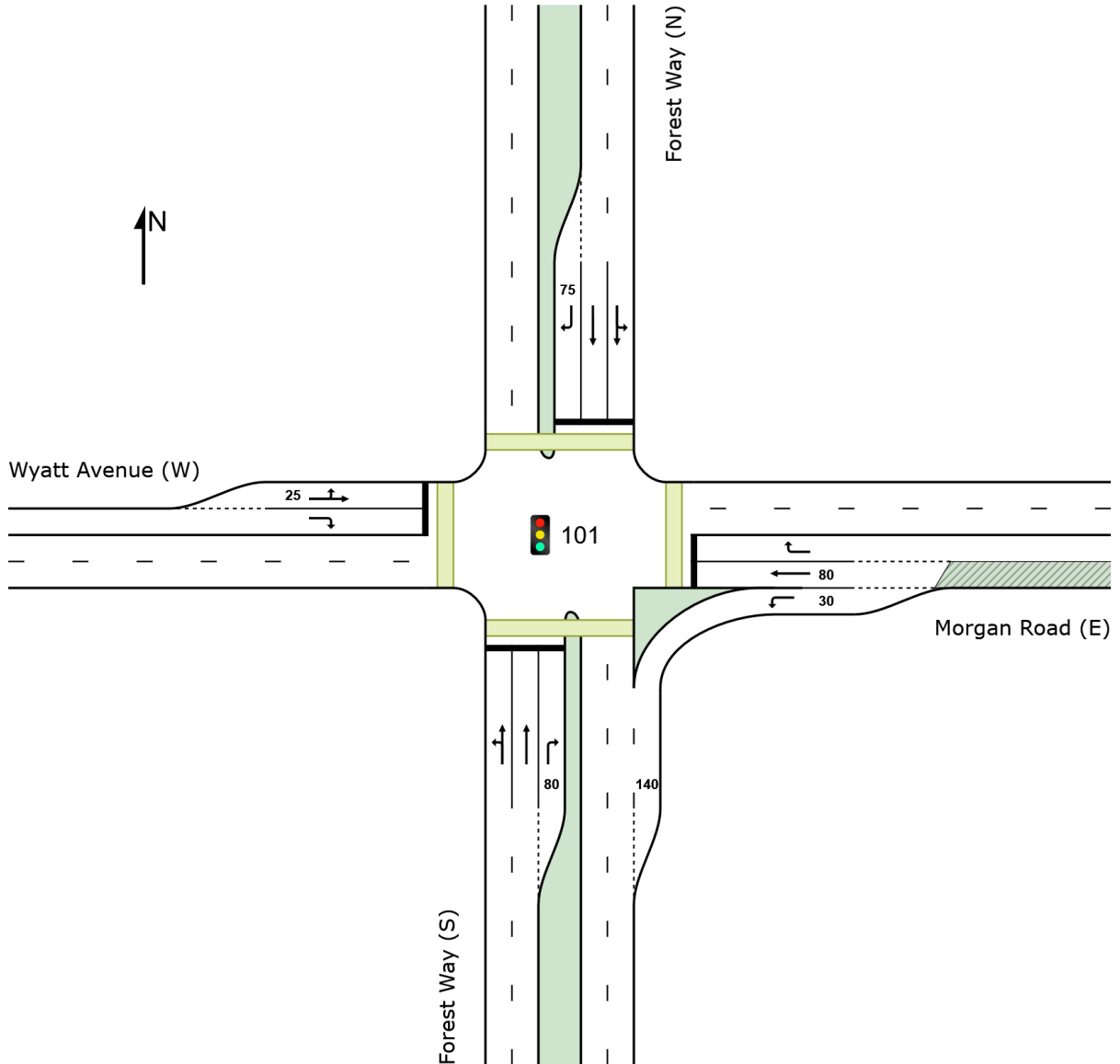

MOVEMENT SUMMARY

Site: 101 [PM FutureBase + PP + Slip Lane (Bushfire) - Full Yield (Site Folder: Forest Way / Morgan Road - Bushfire Evacuation)]

Output produced by SIDRA INTERSECTION Version: 9.1.1.200

Forest Way / Morgan Road

Site Category: (None)

Signals - EQUISAT (Fixed-Time/SCATS) Isolated Cycle Time = 130 seconds (Site User-Given Cycle Time)

Variable Sequence Analysis applied. The results are given for the selected output sequence.

Vehicle Movement Performance															
Mov ID	Turn	Mov Class	Demand Flows		Arrival Flows		Deg. Satn	Aver. Delay	Level of Service	95% Back Of Queue		Prop. Que	Eff. Stop Rate	Aver. No. of Cycles	Aver. Speed
			[Total HV]	%	[Total HV]	%	v/c	sec		[Veh.]	[Dist]				km/h
			veh/h		veh/h					veh	m				
South: Forest Way (S)															
1	L2	All MCs	21	0.0	21	0.0	0.687	21.9	LOS B	33.2	241.8	0.68	0.63	0.68	51.7
2	T1	All MCs	1675	5.0	1675	5.0	0.687	18.0	LOS B	33.2	241.8	0.68	0.63	0.68	54.4
3	R2	All MCs	250.0		250.0		0.033	80.7	LOS F	0.1	1.3	0.98	0.62	0.98	25.5
Approach			1698	5.0	1698	5.0	0.687	18.1	LOS B	33.2	241.8	0.68	0.63	0.68	54.3
East: Morgan Road (E)															
4	L2	All MCs	568	0.0	568	0.0	0.306	15.1	LOS B	0.0	0.0	0.00	0.57	0.00	59.4
5	T1	All MCs	1	0.0	1	0.0	0.003	48.3	LOS D	0.1	0.4	0.86	0.51	0.86	36.5
6	R2	All MCs	250.0		250.0		0.012	59.6	LOS E	0.1	1.2	0.88	0.63	0.88	28.3
Approach			572	0.2	572	0.2	0.306	15.4	LOS B	0.1	1.2	0.00	0.57	0.00	59.1
North: Forest Way (N)															
7	L2	All MCs	1	0.0	1	0.0	*0.808	25.4	LOS B	46.0	331.5	0.80	0.73	0.80	50.1
8	T1	All MCs	1979	3.4	1979	3.4	0.808	22.1	LOS B	46.0	331.5	0.80	0.73	0.80	52.5
9	R2	All MCs	56	13.2	56	13.2	*0.712	89.0	LOS F	3.8	30.0	1.00	0.83	1.18	26.3
Approach			2036	3.6	2036	3.6	0.808	24.0	LOS B	46.0	331.5	0.81	0.74	0.81	51.1
West: Wyatt Avenue (W)															
10	L2	All MCs	48	21.7	48	21.7	0.138	48.1	LOS D	2.6	21.2	0.82	0.74	0.82	33.2
11	T1	All MCs	3	0.0	3	0.0	0.138	51.2	LOS D	2.6	21.2	0.82	0.74	0.82	36.5
12	R2	All MCs	41	7.7	41	7.7	*0.177	59.1	LOS E	2.3	17.2	0.91	0.74	0.91	31.4
Approach			93	14.8	93	14.8	0.177	53.0	LOS D	2.6	21.2	0.86	0.74	0.86	32.5
All Vehicles			4398	3.9	4398	3.9	0.808	21.2	LOS B	46.0	331.5	0.66	0.67	0.66	52.6

Site Level of Service (LOS) Method: Delay (RTA NSW). Site LOS Method is specified in the Parameter Settings dialog (Options tab).

Vehicle movement LOS values are based on average delay per movement.

Intersection and Approach LOS values are based on average delay for all vehicle movements.

Delay Model: SIDRA Standard (Control Delay: Geometric Delay is included).

Queue Model: SIDRA queue estimation methods are used for Back of Queue and Queue at Start of Green.

Gap-Acceptance Capacity Formula: SIDRA Standard (Akçelik M3D).

HV (%) values are calculated for All Movement Classes of All Heavy Vehicle Model Designation.

Arrival Flows used in performance calculations are adjusted to include any Initial Queued Demand and Upstream Capacity Constraint effects.

* Critical Movement (Signal Timing)

Pedestrian Movement Performance											
Mov ID	Input Crossing	Dem. Flow	Aver. Delay	Level of Service	AVERAGE BACK OF QUEUE		Prop. Que	Eff. Stop Rate	Travel Time	Travel Dist.	Aver. Speed
	ped/h	ped/h	sec		[Ped]	[Dist]			sec	m	m/sec
					ped	m					
South: Forest Way (S)											

P1 Full	11	12	59.2	LOS E	0.0	0.0	0.95	0.95	225.8	200.0	0.89
East: Morgan Road (E)											
P2 Full	22	23	59.2	LOS E	0.1	0.1	0.95	0.95	225.9	200.0	0.89
North: Forest Way (N)											
P3 Full	9	9	59.2	LOS E	0.0	0.0	0.95	0.95	225.8	200.0	0.89
West: Wyatt Avenue (W)											
P4 Full	17	18	59.2	LOS E	0.1	0.1	0.95	0.95	225.8	200.0	0.89
All Pedestrians	59	62	59.2	LOS E	0.1	0.1	0.95	0.95	225.8	200.0	0.89

Level of Service (LOS) Method: SIDRA Pedestrian LOS Method (Based on Average Delay)

Pedestrian movement LOS values are based on average delay per pedestrian movement.

Intersection LOS value for Pedestrians is based on average delay for all pedestrian movements.

SIDRA INTERSECTION 9.1 | Copyright © 2000-2022 Akcelik and Associates Pty Ltd | sidrasolutions.com

Organisation: JMT CONSULTING | Licence: NETWORK / 1PC | Processed: Wednesday, 13 September 2023 3:14:02 PM

Project: C:\JMT Consulting\Projects\2046 - Belrose PP\Internal\Belrose SIDRA_Updated Aug23.sip9

PHASING SUMMARY

Site: 101 [PM FutureBase + PP + Slip Lane (Bushfire) - Full Yield (Site Folder: Forest Way / Morgan Road - Bushfire Evacuation)]

Output produced by SIDRA INTERSECTION Version: 9.1.1.200

Forest Way / Morgan Road

Site Category: (None)

Signals - EQUISAT (Fixed-Time/SCATS) Isolated Cycle Time = 130 seconds (Site User-Given Cycle Time)

Variable Sequence Analysis applied. The results are given for the selected output sequence.

Timings based on settings in the Site Phasing & Timing dialog

Phase Times determined by the program

Phase Sequence: Leading Right Turn

Input Phase Sequence: A*, B, B1*, B2*, C

Output Phase Sequence: A*, B, C

Reference Phase: Phase B

(* Variable Phase)

Phase Timing Summary

Phase	A	B	C
Phase Change Time (sec)	118	0	91
Green Time (sec)	6	85	21
Phase Time (sec)	12	91	27
Phase Split	9%	70%	21%
Phase Frequency (%)	100.0 ⁴	100.0 ⁴	100.0 ⁴

See the Timing Analysis report for more detailed information including input values of Yellow Time and All-Red Time, and information on any adjustments to Intergreen Time, Phase Time and Green Time values in cases of Pedestrian Actuation, Minor Phase Actuation and Phase Frequency values (user-specified or implied) less than 100%.





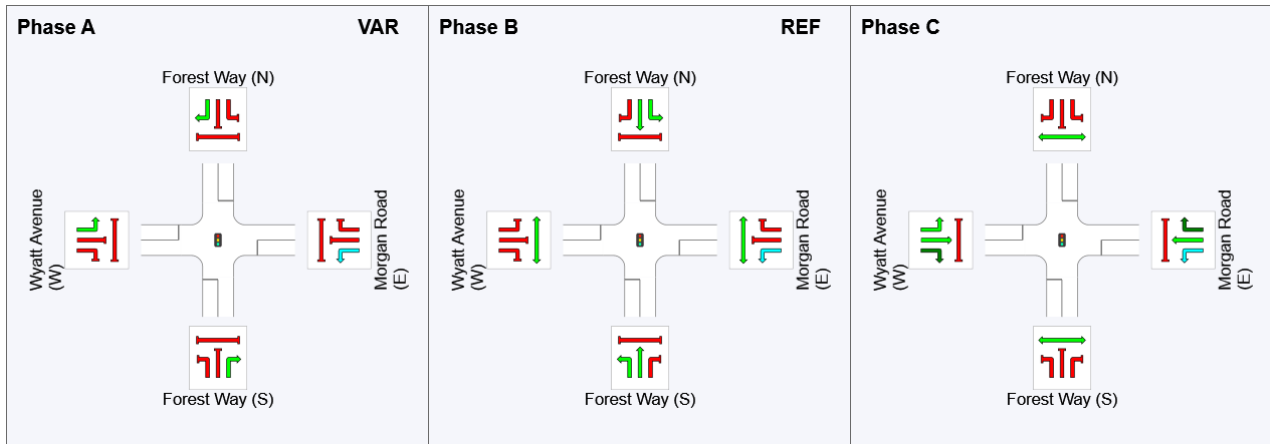







⁴ Phase Frequency specified by the user (phase times not specified).

Output Phase Sequence



REF: Reference Phase

VAR: Variable Phase

	Normal Movement		Permitted/Opposed
	Slip/Bypass-Lane Movement		Opposed Slip/Bypass-Lane
	Stopped Movement		Turn On Red
	Other Movement Class (MC) Running		Undetected Movement
	Mixed Running & Stopped MCs		Continuous Movement
	Other Movement Class (MC) Stopped		Phase Transition Applied

SITE LAYOUT

Site: 101 [PM FutureBase + PP (Bushfire) - 200 lots (Site Folder: Forest Way / Morgan Road - Bushfire Evacuation)]

Forest Way / Morgan Road

Site Category: (None)

Signals - EQUISAT (Fixed-Time/SCATS) Isolated

Layout pictures are schematic functional drawings reflecting input data. They are not design drawings.

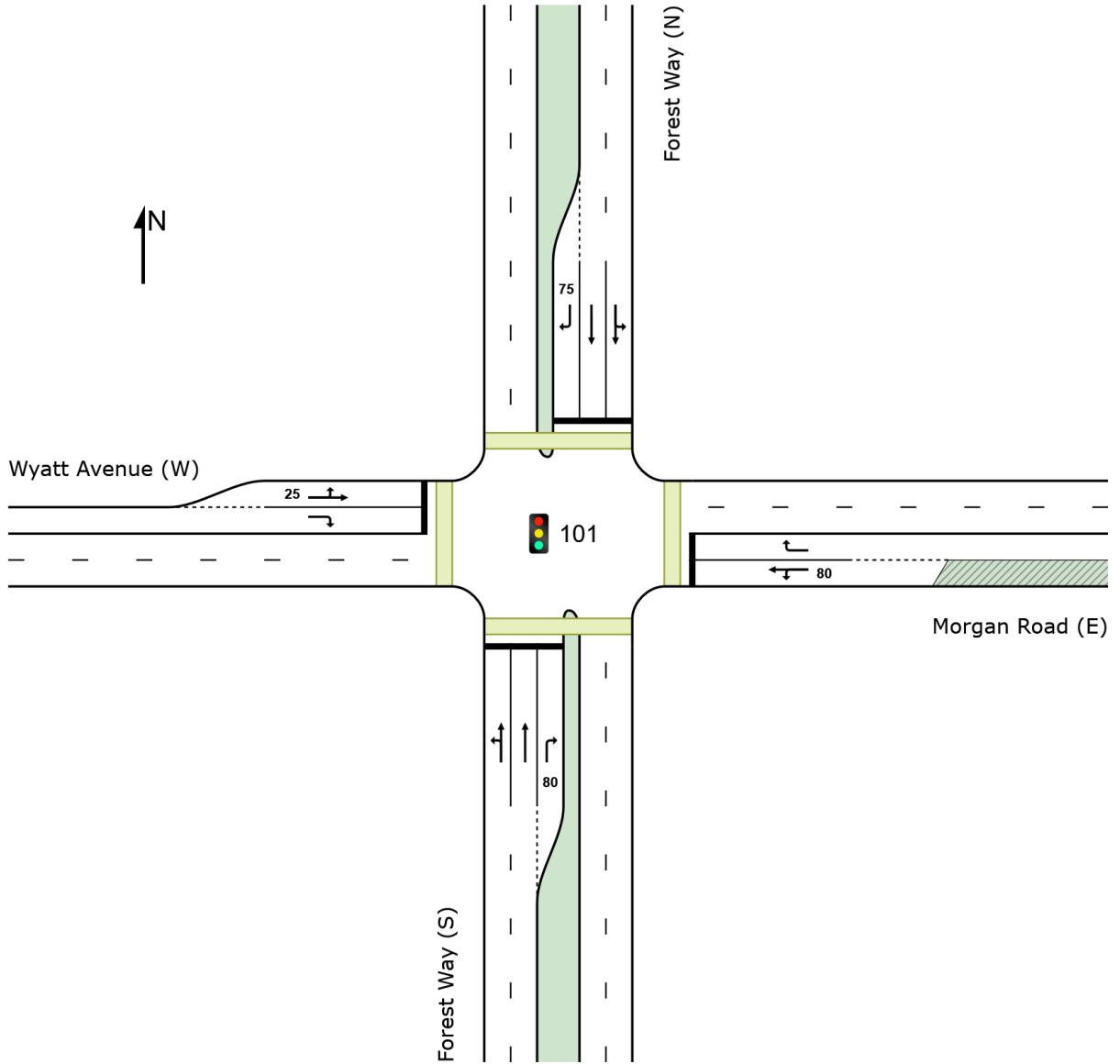

MOVEMENT SUMMARY

Site: 101 [PM FutureBase + PP (Bushfire) - 200 lots (Site Folder: Forest Way / Morgan Road - Bushfire Evacuation)]

Output produced by SIDRA INTERSECTION Version: 9.1.1.200

Forest Way / Morgan Road

Site Category: (None)

Signals - EQUISAT (Fixed-Time/SCATS) Isolated Cycle Time = 130 seconds (Site User-Given Cycle Time)

Variable Sequence Analysis applied. The results are given for the selected output sequence.

Vehicle Movement Performance															
Mov ID	Turn	Mov Class	Demand Flows [Total HV]		Arrival Flows [Total HV]		Deg. Satn	Aver. Delay	Level of Service	95% Back Of Queue [Veh. Dist]		Prop. Que	Eff. Stop Rate	Aver. No. of Cycles	Aver. Speed
			veh/h	%	veh/h	%	v/c	sec		veh	m				km/h
South: Forest Way (S)															
1	L2	All MCs	21	0.0	21	0.0	0.687	21.9	LOS B	33.2	241.8	0.68	0.63	0.68	51.7
2	T1	All MCs	1675	5.0	1675	5.0	0.687	18.0	LOS B	33.2	241.8	0.68	0.63	0.68	54.4
3	R2	All MCs	250.0		250.0		0.033	80.6	LOS F	0.1	1.3	0.98	0.62	0.98	25.3
Approach			1698	5.0	1698	5.0	0.687	18.1	LOS B	33.2	241.8	0.68	0.63	0.68	54.3
East: Morgan Road (E)															
4	L2	All MCs	227	0.0	227	0.0	0.503	51.1	LOS D	12.4	87.1	0.91	0.82	0.91	34.2
5	T1	All MCs	1	0.0	1	0.0	*0.503	55.4	LOS D	12.4	87.1	0.91	0.82	0.91	35.4
6	R2	All MCs	250.0		250.0		0.011	57.5	LOS E	0.1	1.1	0.87	0.63	0.87	28.8
Approach			231	0.5	231	0.5	0.503	51.2	LOS D	12.4	87.1	0.91	0.82	0.91	34.2
North: Forest Way (N)															
7	L2	All MCs	1	0.0	1	0.0	*0.808	25.4	LOS B	46.0	331.5	0.80	0.73	0.80	50.0
8	T1	All MCs	1979	3.4	1979	3.4	0.808	22.1	LOS B	46.0	331.5	0.80	0.73	0.80	52.5
9	R2	All MCs	56	13.2	56	13.2	*0.712	89.0	LOS F	3.8	30.0	1.00	0.83	1.18	26.3
Approach			2036	3.6	2036	3.6	0.808	24.0	LOS B	46.0	331.5	0.81	0.74	0.81	51.1
West: Wyatt Avenue (W)															
10	L2	All MCs	48	21.7	48	21.7	0.138	48.1	LOS D	2.6	21.2	0.82	0.74	0.82	33.2
11	T1	All MCs	3	0.0	3	0.0	0.138	51.2	LOS D	2.6	21.2	0.82	0.74	0.82	36.5
12	R2	All MCs	41	7.7	41	7.7	0.177	59.1	LOS E	2.3	17.2	0.91	0.74	0.91	31.4
Approach			93	14.8	93	14.8	0.177	53.0	LOS D	2.6	21.2	0.86	0.74	0.86	32.5
All Vehicles			4057	4.3	4057	4.3	0.808	23.7	LOS B	46.0	331.5	0.76	0.70	0.76	50.3

Site Level of Service (LOS) Method: Delay (RTA NSW). Site LOS Method is specified in the Parameter Settings dialog (Options tab).

Vehicle movement LOS values are based on average delay per movement.

Intersection and Approach LOS values are based on average delay for all vehicle movements.

Delay Model: SIDRA Standard (Control Delay: Geometric Delay is included).

Queue Model: SIDRA queue estimation methods are used for Back of Queue and Queue at Start of Green.

Gap-Acceptance Capacity Formula: SIDRA Standard (Akçelik M3D).

HV (%) values are calculated for All Movement Classes of All Heavy Vehicle Model Designation.

Arrival Flows used in performance calculations are adjusted to include any Initial Queued Demand and Upstream Capacity Constraint effects.

* Critical Movement (Signal Timing)

Pedestrian Movement Performance												
Mov ID	Input Crossing	Dem. Flow	Aver. Delay	Level of Service	AVERAGE BACK OF QUEUE [Ped Dist]		Prop. Que	Eff. Stop Rate	Travel Time	Travel Dist.	Aver. Speed	
	ped/h	ped/h	sec		ped	m			sec	m	m/sec	
South: Forest Way (S)												
P1	Full	11	12	59.2	LOS E	0.0	0.0	0.95	0.95	225.8	200.0	0.89

East: Morgan Road (E)												
P2	Full	22	23	59.2	LOS E	0.1	0.1	0.95	0.95	225.9	200.0	0.89
North: Forest Way (N)												
P3	Full	9	9	59.2	LOS E	0.0	0.0	0.95	0.95	225.8	200.0	0.89
West: Wyatt Avenue (W)												
P4	Full	17	18	59.2	LOS E	0.1	0.1	0.95	0.95	225.8	200.0	0.89
All	Pedestrians	59	62	59.2	LOS E	0.1	0.1	0.95	0.95	225.8	200.0	0.89

Level of Service (LOS) Method: SIDRA Pedestrian LOS Method (Based on Average Delay)

Pedestrian movement LOS values are based on average delay per pedestrian movement.

Intersection LOS value for Pedestrians is based on average delay for all pedestrian movements.

SIDRA INTERSECTION 9.1 | Copyright © 2000-2022 Akcelik and Associates Pty Ltd | sidrasolutions.com

Organisation: JMT CONSULTING | Licence: NETWORK / 1PC | Processed: Wednesday, 13 September 2023 3:14:03 PM

Project: C:\JMT Consulting\Projects\2046 - Belrose PP\Internal\Belrose SIDRA_Updated Aug23.sip9

PHASING SUMMARY

Site: 101 [PM FutureBase + PP (Bushfire) - 200 lots (Site Folder: Forest Way / Morgan Road - Bushfire Evacuation)]

Output produced by SIDRA INTERSECTION Version: 9.1.1.200

Forest Way / Morgan Road

Site Category: (None)

Signals - EQUISAT (Fixed-Time/SCATS) Isolated Cycle Time = 130 seconds (Site User-Given Cycle Time)

Variable Sequence Analysis applied. The results are given for the selected output sequence.

Timings based on settings in the Site Phasing & Timing dialog

Phase Times determined by the program

Phase Sequence: Leading Right Turn

Input Phase Sequence: A*, B, B1*, B2*, C

Output Phase Sequence: A*, B, C

Reference Phase: Phase B

(* Variable Phase)

Phase Timing Summary

Phase	A	B	C
Phase Change Time (sec)	118	0	91
Green Time (sec)	6	85	21
Phase Time (sec)	12	91	27
Phase Split	9%	70%	21%
Phase Frequency (%)	100.0 ⁴	100.0 ⁴	100.0 ⁴

See the Timing Analysis report for more detailed information including input values of Yellow Time and All-Red Time, and information on any adjustments to Intergreen Time, Phase Time and Green Time values in cases of Pedestrian Actuation, Minor Phase Actuation and Phase Frequency values (user-specified or implied) less than 100%.

⁴ Phase Frequency specified by the user (phase times not specified).

Output Phase Sequence

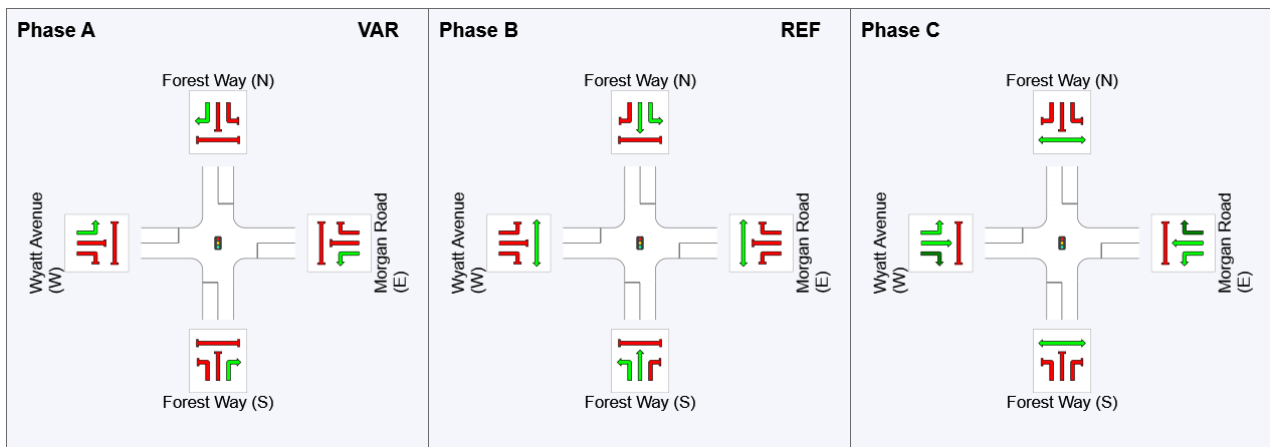

REF: Reference Phase

VAR: Variable Phase

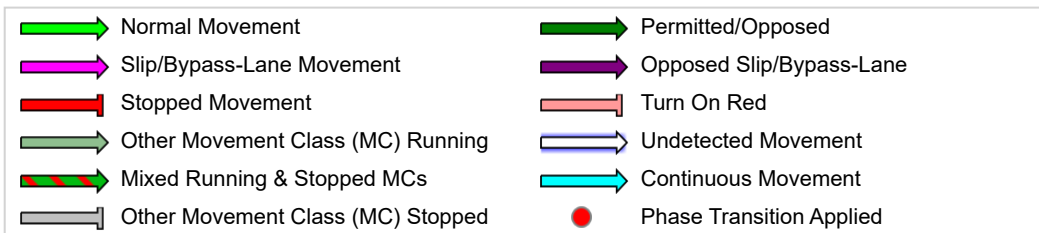

MOVEMENT SUMMARY

 Site: 101 [AM Existing (Site Folder: Wakehurst Pkwy / Oxford Falls Road)]

Output produced by SIDRA INTERSECTION Version: 9.1.1.200

New Site
 Site Category: (None)
 Stop (Two-Way)

Vehicle Movement Performance															
Mov ID	Turn	Mov Class	Demand Flows		Arrival Flows		Deg. Satn	Aver. Delay	Level of Service	95% Back Of Queue		Prop. Que	Eff. Stop Rate	Aver. No. of Cycles	Aver. Speed
			[Total HV]	%	[Total HV]	%	v/c	sec		[Veh. veh	Dist] m				km/h
South: Wakehurst Parkway (S)															
1	L2	All MCs	104	1.0	104	1.0	0.525	6.5	LOS A	0.0	0.0	0.00	0.07	0.00	64.1
2	T1	All MCs	893	3.5	893	3.5	0.525	0.2	LOS A	0.0	0.0	0.00	0.07	0.00	68.6
Approach			997	3.3	997	3.3	0.525	0.9	NA	0.0	0.0	0.00	0.07	0.00	68.1
North: Wakehurst Parkway (N)															
8	T1	All MCs	1254	2.1	1254	2.1	0.702	0.1	LOS A	0.6	4.1	0.05	0.07	0.12	69.2
9	R2	All MCs	40	0.0	40	0.0	0.702	13.9	LOS A	0.6	4.1	0.05	0.07	0.12	64.9
Approach			1294	2.0	1294	2.0	0.702	0.6	NA	0.6	4.1	0.05	0.07	0.12	69.1
West: Oxford Falls Road (W)															
10	L2	All MCs	34	0.0	34	0.0	0.084	16.3	LOS B	0.3	1.9	0.74	1.00	0.74	51.9
12	R2	All MCs	44	2.4	44	2.4	0.338	35.0	LOS C	0.8	5.7	0.94	1.02	1.07	40.6
Approach			78	1.4	78	1.4	0.338	26.9	LOS B	0.8	5.7	0.85	1.01	0.93	44.9
All Vehicles			2368	2.5	2368	2.5	0.702	1.6	NA	0.8	5.7	0.05	0.10	0.09	67.5

Site Level of Service (LOS) Method: Delay (RTA NSW). Site LOS Method is specified in the Parameter Settings dialog (Options tab).

Vehicle movement LOS values are based on average delay per movement.

Minor Road Approach LOS values are based on average delay for all vehicle movements.

NA (TWSC): Level of Service is not defined for major road approaches or the intersection as a whole for Two-Way Sign Control (HCM LOS rule).

Two-Way Sign Control Capacity Model: SIDRA Standard.

Delay Model: SIDRA Standard (Control Delay: Geometric Delay is included).

Queue Model: SIDRA queue estimation methods are used for Back of Queue and Queue at Start of Gap.

Gap-Acceptance Capacity Formula: SIDRA Standard (Akçelik M3D).

HV (%) values are calculated for All Movement Classes of All Heavy Vehicle Model Designation.

Arrival Flows used in performance calculations are adjusted to include any Initial Queued Demand and Upstream Capacity Constraint effects.

MOVEMENT SUMMARY

 Site: 101 [PM Existing (Site Folder: Wakehurst Pkwy / Oxford Falls Road)]

Output produced by SIDRA INTERSECTION Version: 9.1.1.200

New Site
 Site Category: (None)
 Stop (Two-Way)

Vehicle Movement Performance															
Mov ID	Turn	Mov Class	Demand Flows		Arrival Flows		Deg. Satn	Aver. Delay	Level of Service	95% Back Of Queue		Prop. Que	Eff. Stop Rate	Aver. No. of Cycles	Aver. Speed
			[Total HV]	%	[Total HV]	%	v/c	sec		[Veh.]	[Dist]				km/h
			veh/h		veh/h					veh	m				
South: Wakehurst Parkway (S)															
1	L2	All MCs	59	1.8	59	1.8	0.729	6.8	LOS A	0.0	0.0	0.00	0.03	0.00	63.8
2	T1	All MCs	1344	1.6	1344	1.6	0.729	0.5	LOS A	0.0	0.0	0.00	0.03	0.00	68.4
Approach			1403	1.7	1403	1.7	0.729	0.7	NA	0.0	0.0	0.00	0.03	0.00	68.2
North: Wakehurst Parkway (N)															
8	T1	All MCs	845	3.4	845	3.4	0.443	0.1	LOS A	0.0	0.0	0.00	0.00	0.00	69.6
9	R2	All MCs	26	0.0	26	0.0	0.114	18.6	LOS B	0.3	1.9	0.86	0.94	0.86	49.1
Approach			872	3.3	872	3.3	0.443	0.7	NA	0.3	1.9	0.03	0.03	0.03	68.8
West: Oxford Falls Road (W)															
10	L2	All MCs	42	2.5	42	2.5	0.259	29.0	LOS C	0.7	4.8	0.91	1.03	1.00	38.9
12	R2	All MCs	34	0.0	34	0.0	0.288	37.1	LOS C	0.7	5.2	0.95	1.02	1.04	35.8
Approach			76	1.4	76	1.4	0.288	32.6	LOS C	0.7	5.2	0.92	1.02	1.02	37.5
All Vehicles			2351	2.2	2351	2.2	0.729	1.7	NA	0.7	5.2	0.04	0.06	0.04	66.7

Site Level of Service (LOS) Method: Delay (RTA NSW). Site LOS Method is specified in the Parameter Settings dialog (Options tab).

Vehicle movement LOS values are based on average delay per movement.

Minor Road Approach LOS values are based on average delay for all vehicle movements.

NA (TWSC): Level of Service is not defined for major road approaches or the intersection as a whole for Two-Way Sign Control (HCM LOS rule).

Two-Way Sign Control Capacity Model: SIDRA Standard.

Delay Model: SIDRA Standard (Control Delay: Geometric Delay is included).

Queue Model: SIDRA queue estimation methods are used for Back of Queue and Queue at Start of Gap.

Gap-Acceptance Capacity Formula: SIDRA Standard (Akçelik M3D).

HV (%) values are calculated for All Movement Classes of All Heavy Vehicle Model Designation.

Arrival Flows used in performance calculations are adjusted to include any Initial Queued Demand and Upstream Capacity Constraint effects.

MOVEMENT SUMMARY

 Site: 101 [AM Existing + Proposal (Site Folder: Wakehurst Pkwy / Oxford Falls Road)]

Output produced by SIDRA INTERSECTION Version: 9.1.1.200

New Site
 Site Category: (None)
 Stop (Two-Way)

Vehicle Movement Performance															
Mov ID	Turn	Mov Class	Demand Flows		Arrival Flows		Deg. Satn	Aver. Delay	Level of Service	95% Back Of Queue		Prop. Que	Eff. Stop Rate	Aver. No. of Cycles	Aver. Speed
			[Total HV]	%	[Total HV]	%	v/c	sec		[Veh.]	[Dist]				km/h
			veh/h		veh/h					veh	m				
South: Wakehurst Parkway (S)															
1	L2	All MCs	120	0.9	120	0.9	0.533	6.5	LOS A	0.0	0.0	0.00	0.07	0.00	64.1
2	T1	All MCs	893	3.5	893	3.5	0.533	0.2	LOS A	0.0	0.0	0.00	0.07	0.00	68.5
Approach			1013	3.2	1013	3.2	0.533	1.0	NA	0.0	0.0	0.00	0.07	0.00	67.9
North: Wakehurst Parkway (N)															
8	T1	All MCs	1254	2.1	1254	2.1	0.713	0.2	LOS A	0.7	5.1	0.06	0.08	0.15	69.1
9	R2	All MCs	48	0.0	48	0.0	0.713	14.2	LOS A	0.7	5.1	0.06	0.08	0.15	64.7
Approach			1302	2.0	1302	2.0	0.713	0.7	NA	0.7	5.1	0.06	0.08	0.15	68.9
West: Oxford Falls Road (W)															
10	L2	All MCs	66	0.0	66	0.0	0.165	16.6	LOS B	0.6	3.9	0.75	1.00	0.75	51.7
12	R2	All MCs	109	1.0	109	1.0	0.806	54.6	LOS D	2.6	18.5	0.98	1.15	1.77	33.5
Approach			176	0.6	176	0.6	0.806	40.3	LOS C	2.6	18.5	0.90	1.09	1.39	38.6
All Vehicles			2491	2.4	2491	2.4	0.806	3.6	NA	2.6	18.5	0.09	0.15	0.17	64.9

Site Level of Service (LOS) Method: Delay (RTA NSW). Site LOS Method is specified in the Parameter Settings dialog (Options tab).

Vehicle movement LOS values are based on average delay per movement.

Minor Road Approach LOS values are based on average delay for all vehicle movements.

NA (TWSC): Level of Service is not defined for major road approaches or the intersection as a whole for Two-Way Sign Control (HCM LOS rule).

Two-Way Sign Control Capacity Model: SIDRA Standard.

Delay Model: SIDRA Standard (Control Delay: Geometric Delay is included).

Queue Model: SIDRA queue estimation methods are used for Back of Queue and Queue at Start of Gap.

Gap-Acceptance Capacity Formula: SIDRA Standard (Akçelik M3D).

HV (%) values are calculated for All Movement Classes of All Heavy Vehicle Model Designation.

Arrival Flows used in performance calculations are adjusted to include any Initial Queued Demand and Upstream Capacity Constraint effects.

MOVEMENT SUMMARY

 Site: 101 [PM Existing + Proposal (Site Folder: Wakehurst Pkwy / Oxford Falls Road)]

Output produced by SIDRA INTERSECTION Version: 9.1.1.200

New Site
 Site Category: (None)
 Stop (Two-Way)

Vehicle Movement Performance															
Mov ID	Turn	Mov Class	Demand Flows		Arrival Flows		Deg. Satn	Aver. Delay	Level of Service	95% Back Of Queue		Prop. Que	Eff. Stop Rate	Aver. No. of Cycles	Aver. Speed
			[Total HV]	%	[Total HV]	%	v/c	sec		[Veh.]	[Dist]				km/h
			veh/h		veh/h					veh	m				
South: Wakehurst Parkway (S)															
1	L2	All MCs	126	0.8	126	0.8	0.765	6.8	LOS A	0.0	0.0	0.00	0.05	0.00	63.6
2	T1	All MCs	1344	1.6	1344	1.6	0.765	0.6	LOS A	0.0	0.0	0.00	0.05	0.00	67.8
Approach			1471	1.6	1471	1.6	0.765	1.1	NA	0.0	0.0	0.00	0.05	0.00	67.4
North: Wakehurst Parkway (N)															
8	T1	All MCs	845	3.4	845	3.4	0.443	0.1	LOS A	0.0	0.0	0.00	0.00	0.00	69.6
9	R2	All MCs	60	0.0	60	0.0	0.324	24.5	LOS B	0.8	5.8	0.91	0.99	1.04	45.5
Approach			905	3.1	905	3.1	0.443	1.8	NA	0.8	5.8	0.06	0.07	0.07	67.3
West: Oxford Falls Road (W)															
10	L2	All MCs	49	2.1	49	2.1	0.299	29.3	LOS C	0.8	5.7	0.91	1.03	1.03	38.8
12	R2	All MCs	51	0.0	51	0.0	0.488	47.5	LOS D	1.3	9.2	0.97	1.05	1.17	32.5
Approach			100	1.1	100	1.1	0.488	38.5	LOS C	1.3	9.2	0.94	1.04	1.10	35.4
All Vehicles			2476	2.1	2476	2.1	0.765	2.9	NA	1.3	9.2	0.06	0.10	0.07	65.0

Site Level of Service (LOS) Method: Delay (RTA NSW). Site LOS Method is specified in the Parameter Settings dialog (Options tab).

Vehicle movement LOS values are based on average delay per movement.

Minor Road Approach LOS values are based on average delay for all vehicle movements.

NA (TWSC): Level of Service is not defined for major road approaches or the intersection as a whole for Two-Way Sign Control (HCM LOS rule).

Two-Way Sign Control Capacity Model: SIDRA Standard.

Delay Model: SIDRA Standard (Control Delay: Geometric Delay is included).

Queue Model: SIDRA queue estimation methods are used for Back of Queue and Queue at Start of Gap.

Gap-Acceptance Capacity Formula: SIDRA Standard (Akçelik M3D).

HV (%) values are calculated for All Movement Classes of All Heavy Vehicle Model Designation.

Arrival Flows used in performance calculations are adjusted to include any Initial Queued Demand and Upstream Capacity Constraint effects.